

# CHELSEA®

Bulletin HY25-1396-M1/US

## Owner's Manual Power Take-Offs

Effective: June 2004  
Supersedes: HY25-1396-M1/US  
April 2003

---

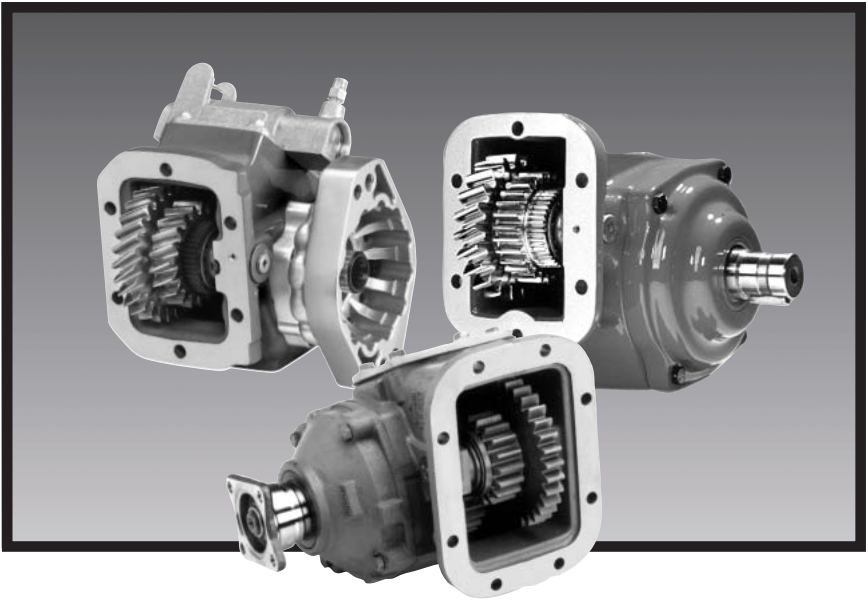

**540 Series**  
**541 Series**



---

 **WARNING**

FAILURE OR IMPROPER SELECTION OR IMPROPER USE OF THE PRODUCTS AND/OR SYSTEMS DESCRIBED HEREIN OR RELATED ITEMS CAN CAUSE DEATH, PERSONAL INJURY AND PROPERTY DAMAGE.

This document and other information from Parker Hannifin Corporation, its subsidiaries and authorized distributors provide product and/or system options for further investigation by users having technical expertise. It is important that you analyze all aspects of your application and review the information concerning the product or system in the current product catalog. Due to the variety of operating conditions and applications for these products or systems, the user, through its own analysis and testing, is solely responsible for making the final selection of the products and systems and assuring that all performance, safety and warning requirements of the application are met.

The products described herein, including without limitation, product features, specifications, designs, availability and pricing, are subject to change by Parker Hannifin Corporation and its subsidiaries at any time without notice.

**Offer of Sale**

The items described in this document are hereby offered for sale by Parker Hannifin Corporation, its subsidiaries or its authorized distributors. This offer and its acceptance are governed by the provisions stated in the "Offer of Sale".

**Patent Information**

The Chelsea® Power Take-Off or its components shipped with this owner's manual may be manufactured under one or more of the following U.S. patents:

4610175   5228355   4597301   5645363   6151975   6142274   6260682

Other patents pending.

© Copyright 2005, Parker Hannifin Corporation, All Rights Reserved

**Contents****General Information**

<b>Safety Information</b> .....	1-6
<b>Model Number Designations</b> .....	7
540 Countershaft .....	7
541 Thrushaft for Fuller .....	7
<b>Horsepower - Torque - R.P.M. Conversion Chart</b> .....	8

**Dimensional Drawings**

540 Countershaft .....	9
541 Thrushaft for Fuller .....	10
540 Countershaft for Volvo .....	11

**Operating Instructions**

541 Thrushaft for Fuller .....	12
540 Countershaft for Volvo .....	12
540 Countershaft for Fuller .....	13-15
540 Countershaft for Spicer .....	16-17

**Installation Instructions**

541 Thrushaft for Fuller .....	18-20
540 Countershaft for Volvo R5 .....	21-26
540 Countershaft for Volvo R6 .....	27-33
540 Countershaft for Fuller .....	34-36
540 Countershaft for Spicer .....	37-41

**Airshift Installation Circuits**

540/541 Countershaft for Fuller .....	42
540 Countershaft for a Spicer .....	43-48
Requiring Neutral Detent Kit	

**Wire Shift P.T.O.s**

Cable Control Installation Instructions .....	49-53
---	-------

**Shift Indicator Continuity Check** ..... 54**Indicator Light Installation/Dash Drilling Template** ..... 55**Dash Drilling Template**

Shift Valve and Light 68-P-27 .....	56
Shift Valve and Light 68-P-28 .....	57
Air Shift and Indicator Light 68-P-30 .....	58

**P.T.O. Maintenance** ..... 59**Offer of Sale** ..... 60

## Safety Information

These instructions are for your safety and the safety of the end user. Read them carefully until you understand them.

### General Safety Information

#### To prevent injury to yourself and/or damage to the equipment:

- Read carefully all owner's manuals, service manuals, and/or other instructions.
- Always follow proper procedures, and use proper tools and safety equipment.
- Be sure to receive proper training.
- Never work alone while under a vehicle or while repairing or maintaining equipment.
- Always use proper components in applications for which they are approved.
- Be sure to assemble components properly.
- Never use wornout or damaged components.
- Always block any raised or moving device that may injure a person working on or under a vehicle.
- Never operate the controls of the Power Take-Off or other driven equipment from any position that could result in getting caught in the moving machinery.

#### Proper Matching of P.T.O.



**WARNING:** A Power Take-Off must be properly matched to the vehicle transmission and to the auxiliary equipment being powered. An improperly matched Power Take-Off could cause severe damage to the vehicle transmission, the auxiliary driveshaft, and/or to the auxiliary equipment being powered. **Damaged components or equipment could malfunction causing serious personal injury to the vehicle operator or to others nearby.**

#### To avoid personal injury and/or equipment damage:

- Always refer to Chelsea catalogs, literature, and owner's manuals and follow Chelsea recommendations when selecting, installing, repairing, or operating a Power Take-Off.
- Never attempt to use a Power Take-Off not specifically recommended by Chelsea for the vehicle transmission.
- Always match the Power Take-Off's specified output capabilities to the requirements of the equipment to be powered.
- Never use a Power Take-Off whose range of speed could exceed the maximum safe speed of the equipment to be powered.



**This symbol warns of possible personal injury.**

## Safety Information

### Cold Weather Operation of Powershift P.T.O.s



**WARNING:** During extreme cold weather operation [32° F (0° C) and lower], a disengaged Powershift Power Take-Off can momentarily transmit high torque that will cause unexpected output shaft rotation. This is caused by the high viscosity of the transmission oil when it is extremely cold. As slippage occurs between the Power Take-Off clutch plates, the oil will rapidly heat up and the viscous drag will quickly decrease.

The Power Take-Off output shaft rotation could cause unexpected movement of the driven equipment resulting in serious personal injury, death, or equipment damage.

#### To avoid personal injury or equipment damage:

- Driven equipment must have separate controls.
- The driven equipment must be left in the disengaged position when not in operation.
- Do not operate the driven equipment until the vehicle is allowed to warm up.

### Rotating Auxiliary Driveshafts



**WARNING:**



- Rotating auxiliary driveshafts are dangerous. You can snag clothes, skin, hair, hands, etc. This can cause serious injury or death.
- Do not go under the vehicle when the engine is running.
- Do not work on or near an exposed shaft when the engine is running.
- Shut off the engine before working on the Power Take-Off or driven equipment.
- Exposed rotating driveshafts must be guarded.

### Guarding Auxiliary Driveshafts



**WARNING:** We strongly recommend that a Power Take-Off and a directly mounted pump be used to eliminate the auxiliary driveshaft whenever possible. If an auxiliary driveshaft is used and remains exposed after installation, it is the responsibility of the vehicle designer and P.T.O. installer to install a guard.



**This symbol warns of possible personal injury.**

## Safety Information

### Using Set Screws



**WARNING:** Auxiliary driveshafts may be installed with either recessed or protruding set screws. If you choose a square head set screw, you should be aware that it will protrude above the hub of the yoke and may be a point where clothes, skin, hair, hands, etc. could be snagged. A socket head set screw, which may not protrude above the hub of the yoke, does not permit the same amount of torquing as does a square head set screw. Also, a square head set screw, if used with a lock wire, will prevent loosening of the screw caused by vibration. Regardless of the choice made with respect to a set screw, an exposed rotating auxiliary driveshaft must be guarded.

### Important: Safety Information and Owner's Manual

Chelsea Power Take-Offs are packaged with safety information decals, instructions, and an owner's manual. These items are located in the envelope with the P.T.O. mounting gaskets. Also, safety information and installation instructions are packaged with some individual parts and kits. Be sure to read the owner's manual before installing or operating the P.T.O. Always install the safety information decals according to the instructions provided. Place the owner's manual in the vehicle glove compartment.



### **WARNING: Operating the P.T.O. with the Vehicle in Motion**

Some Power Take-Offs may be operated when the vehicle is in motion. To do so, the P.T.O. must have been properly selected to operate at highway speeds and correctly matched to the vehicle transmission and the requirements of the driven equipment.

If in doubt about the P.T.O.'s specifications and capabilities, avoid operating the P.T.O. when the vehicle is in motion. Improper application and/or operation can cause serious personal injury or premature failure of the vehicle, the driven equipment, and/or the P.T.O.

Always remember to disengage the P.T.O. when the driven equipment is not in operation.

### **Pump Installation Precautions (see next page)**

Use a bracket to support the pump to the transmission if:

- The pump weighs **40 pounds** or more.
- The combined length of the P.T.O. and pump is **18 inches** or more from the P.T.O. centerline to the end of the pump.

Also remember to pack the female pilot of the P.T.O. pump flange with grease before installing the pump on the P.T.O.

**CAUTION:** When installing the 489 Series P.T.O. several direct mount pump flange options may interfere with the mounting fasteners directly under the flange. The nut must be threaded far enough onto the stud before the remaining (6) six capscrews and other nut are tightened to prevent interference with the flange and possible breakage of the P.T.O. housing.



**This symbol warns of possible personal injury.**

## Direct Mount Pump Support Recommendations

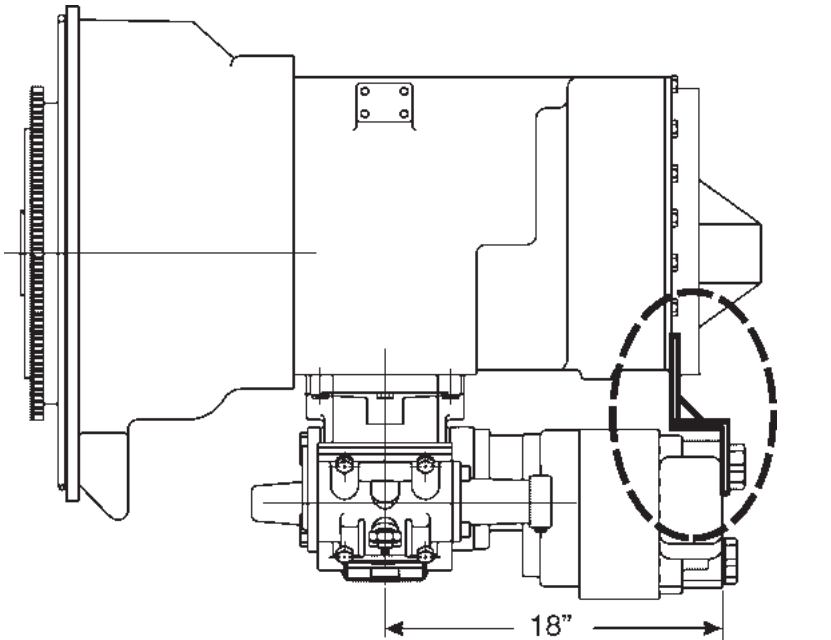

**Note:** For Proper Bracketing Attach At 2 or more Transmission Bolt Locations and 2 or More Pump Locations.

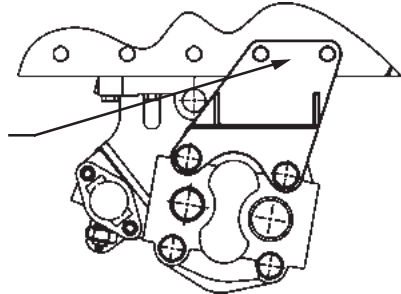

**⚠ Use caution to ensure that bracket does not pre-load pump/ P.T.O. mounting**

Chelsea strongly recommends the use of pump supports (Support Brackets) in all applications. P.T.O. warranty will be void if a pump bracket is not used when:

- 1) The combined weight of pump, fittings and hose exceed **40 pounds**.
- 2) The combined length of the P.T.O. and pump is **18 inches** or more from the P.T.O. centerline to the end of the pump.

**ALSO:** Remember to pack the female pilot of the P.T.O. pump shaft with grease before installing the pump on the P.T.O. (reference Chelsea grease pack 379688)

**⚠ This symbol warns of possible personal injury.**

## Foreword

Since it is our major objective to show you how to get additional and more profitable miles from truck, tractor, and trailer components, we want to provide you with information on the installation of Chelsea Power Take-Offs.

We all realize that an inadequate transmission will overwork any power take-off in a very short period of time. In addition, a mismatched transmission/P.T.O. combination can result in unsatisfactory performance of the equipment right from the start.

Before you order new trucks, be sure that you're getting the right transmission/P.T.O. combination. This is vital for efficient performance and adequate power. To help you select the proper type, size, and design of P.T.O., discuss your specific requirements with a Chelsea P.T.O. specialist. They know their products and have easy access to equipment, transmission, and Power Take-Off manufacturers. They can tell you everything you need to know about power, at the right time, before you specify components.

## Chelsea P.T.O. Safety Label Instructions

1. The two black and orange on white 5" x 7" pressure sensitive vinyl labels, part number 379274; must be placed on the vehicle frame rails (one (1) on each side), in a position that would be HIGHLY visible to anyone that would go under the truck near the P.T.O. rotating shaft. If the vehicle is to be painted after these labels are installed, cover them with two-(2) blank masking covers. Remove the masking covers after painting.
2. Place the one (1) black and orange on white 3.5" x 5" pressure sensitive vinyl label, part number 379275, on the visor nearest the operator of the vehicle, this must be placed near the P.T.O. visor label.
3. Place the one (1) red and white with black lettering 3.5" x 7.5" sensitive vinyl label, part number 379915, on the opposite side of the visor from the above label # 379275.
4. Place the one (1) white and black heavy duty card, part number 379276, in the vehicle glove box. Again in a position highly visible to the operator, for example: try to place this card on top of whatever may be in the glove box.

If you require additional labels, please order part number 328946X at no charge from your local Chelsea Warehouse or send request direct to:

**Parker Hannifin Corporation**  
**Chelsea Products Division**  
**8225 Hacks Cross Road**  
**Olive Branch, MS 38654**  
**Customer Service: (662) 895-1011**



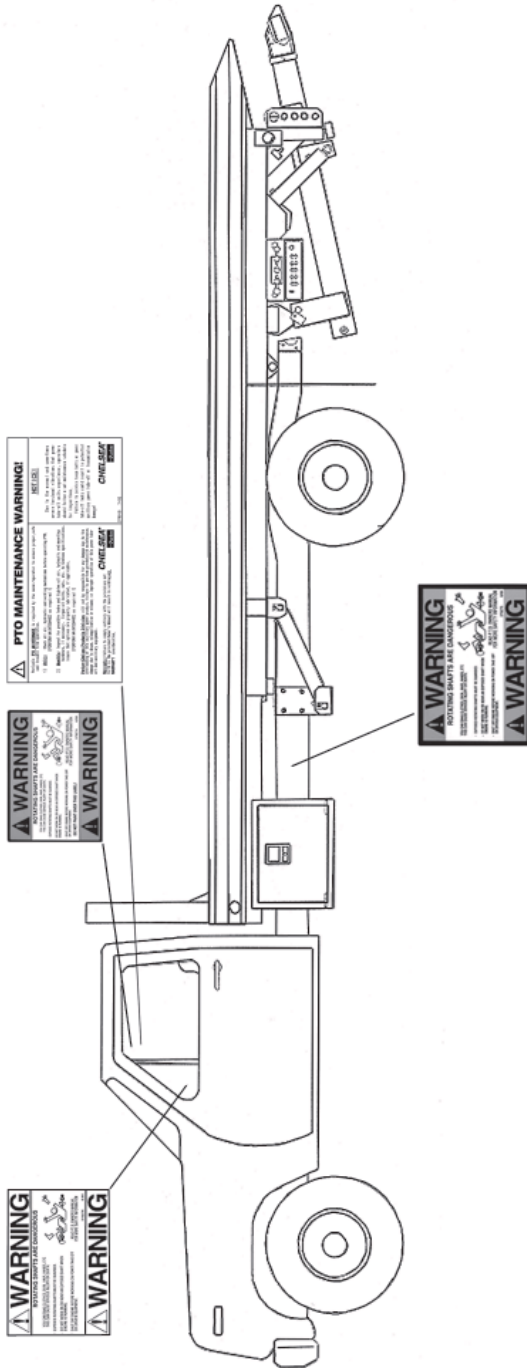

## 540 Countershaft

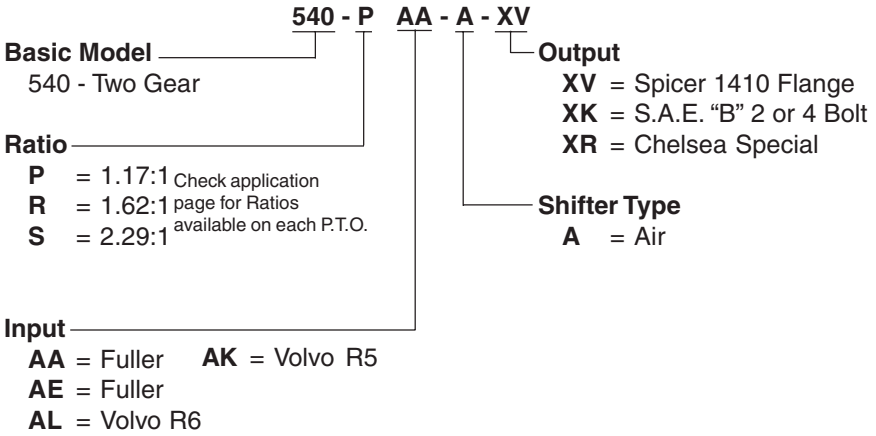

## 541 Thrushaft for Fuller

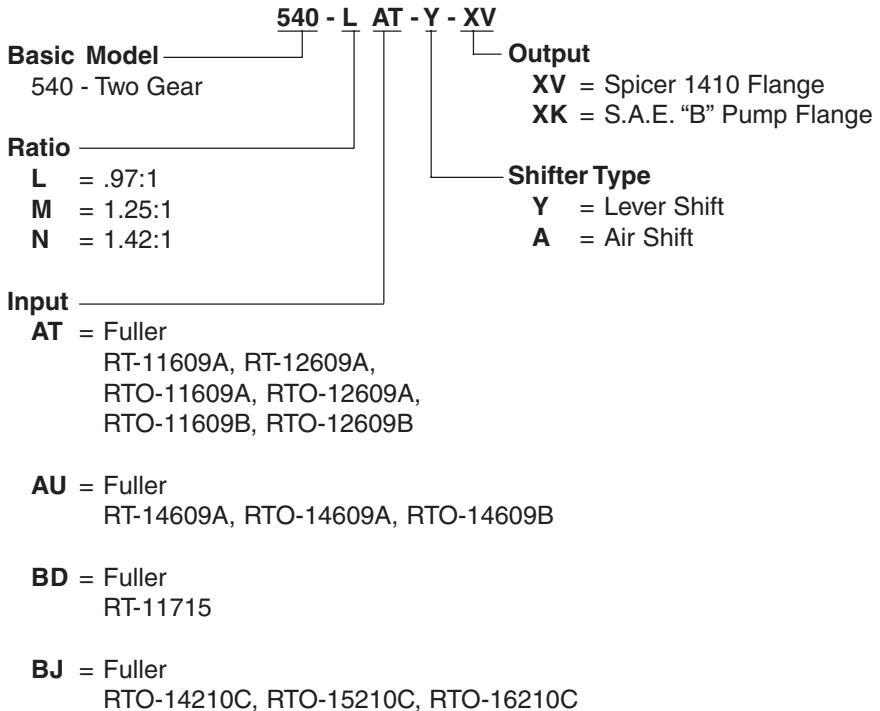

## Horsepower-Torque-R.P.M. Conversion Chart

**To find the Torque:** Given: 100 HP at 1750 R.P.M.

Then: with a straight edge on HP scale at 100 (Left Side) and on R.P.M. scale at 1750.

Find Answer on T scale = 300 pounds feet torque (Middle).

Formula:  $\frac{HP \times 5252}{R.P.M.} = T$  pounds Feet Torque

**To find the HP.** Given: 3 pounds feet torque at 1750 R.P.M.

Then: with a straight edge on the "T" scale at 3 (Middle) and on the R.P.M. scale at 1750.

Find Answer on the HP Scale = 1 Horsepower (Left Side)

Formula:  $\frac{T \times R.P.M.}{5252} = \text{Horsepower}$

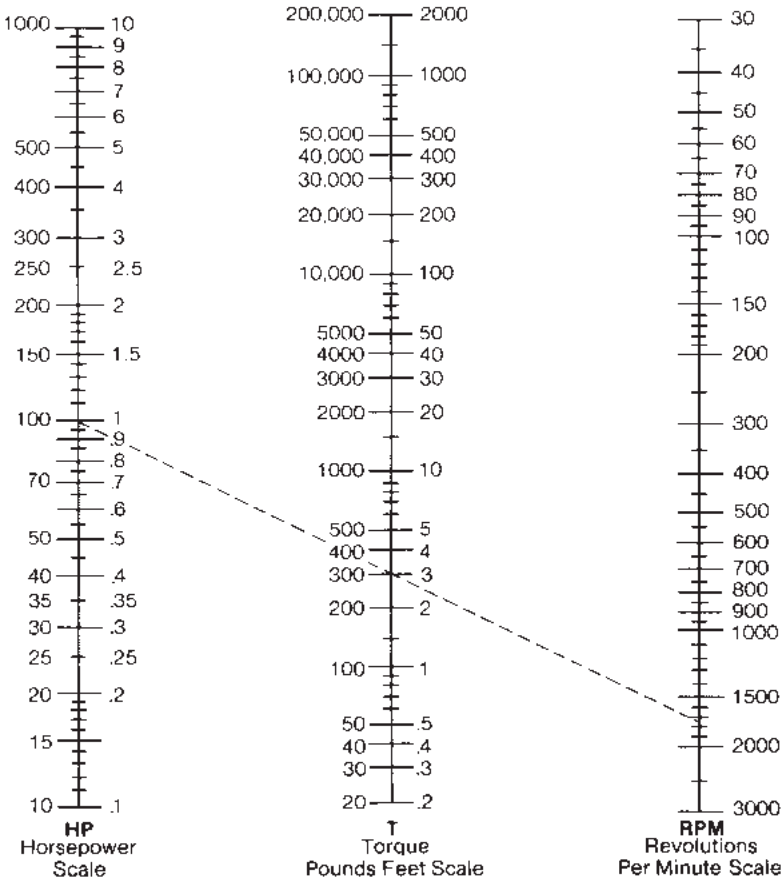

**540 Series**

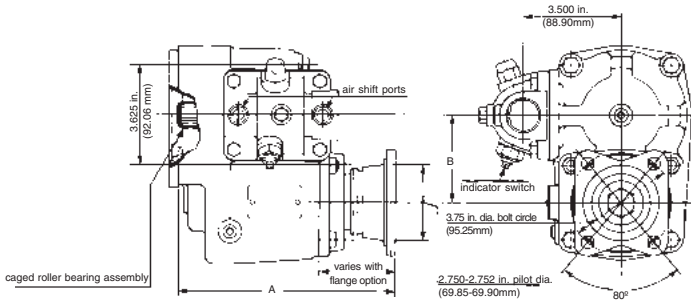

	<b>A</b>	<b>B<sup>1</sup></b>	<b>B<sup>2</sup></b>
AA	7.875" (200.03mm)	3.150" (80.01mm)	2.800" (71.12mm)
AD	8.375" (212.73mm)	3.150" (80.01mm)	Not Applicable
AE	8.375" (212.73mm)	3.150" (80.01mm)	Not Applicable
AQ	8.135" (206.63mm)	3.150" (80.01mm)	2.800" (71.12mm)

B<sup>1</sup> is for "P & R" Ratios

B<sup>2</sup> is for "S" Ratio

### 541 Thrustshaft for Fuller

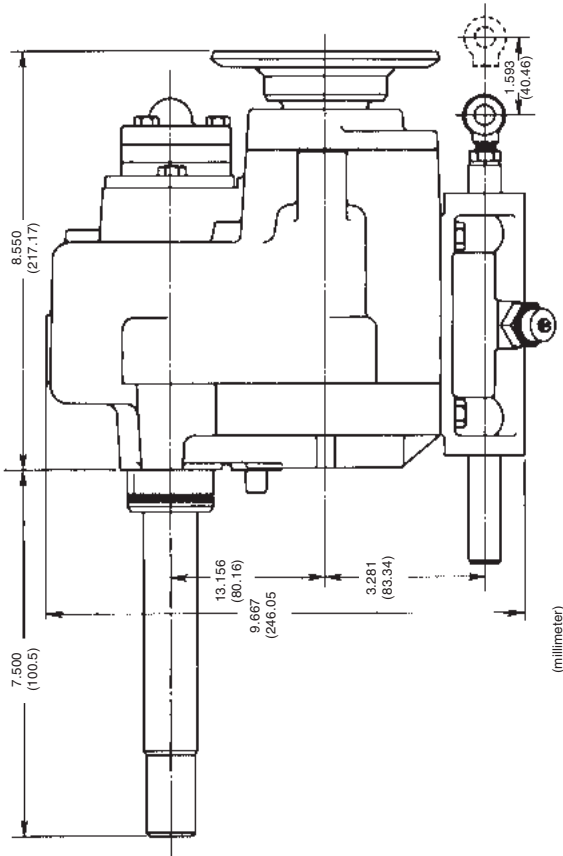
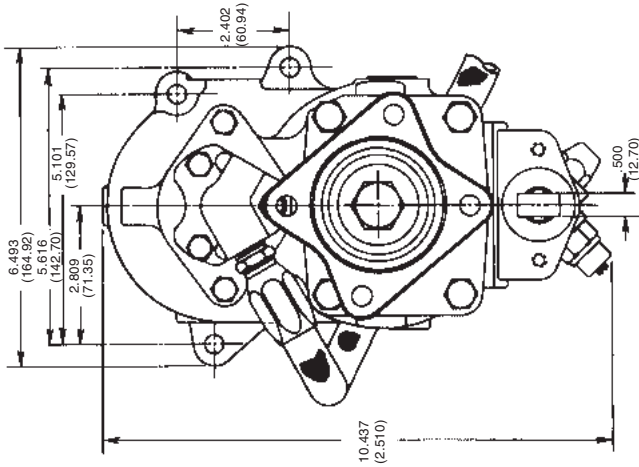

(millimeter)

## 540 Countershaft for Volvo

### 540-\*AK Dimensions

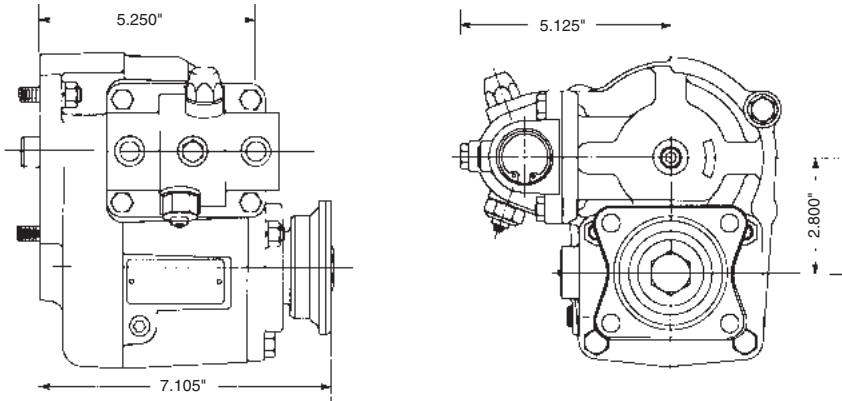

### 540-\*AL Dimensions

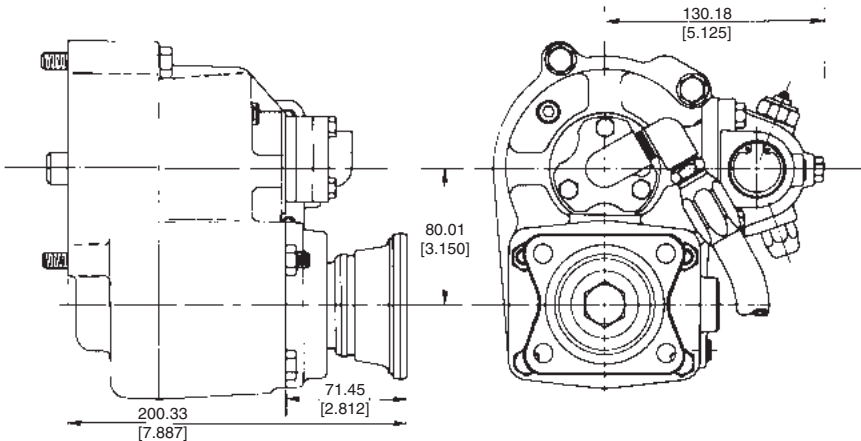

## **540 Countershaft for Volvo and 541 Thrushaft for Fuller**

### **P.T.O. Shifting Procedure & Precautions**

#### **CAUTION**

**This vehicle is equipped with a POWER TAKE-OFF. Shut Engine Off Before Working On POWER TAKE-OFF Or Getting Below Vehicle. Consult Operating Instructions Before Using. (See Sun Visor)**

#### **POWER TAKE-OFF OPERATION - VEHICLE STATIONARY**

##### **A. To Engage the Countershaft P.T.O.**

1. Disengage the vehicle clutch and stop the vehicle.
2. Set the parking brakes and place the main transmission in neutral.
3. Engage the Countershaft P.T.O.
4. The light mounted next to the P.T.O. control will light when the P.T.O is engaged.
5. Slowly engage the clutch. The Countershaft P.T.O. will now start to rotate.

##### **B. To Disengage the P.T.O.**

1. Disengage the vehicle clutch and wait for the Countershaft to stop rotating.
2. Disengage the Countershaft P.T.O.
3. The light mounted next to the P.T.O. control will be "Off" when the P.T.O. is disengaged.

**IMPORTANT: Failure to follow proper shifting or operating sequences will result in premature P.T.O. failure with possible damage to other equipment.**

## 540 Countershaft for Fuller

### Range Control Valve

**(A-3546)** up for high range

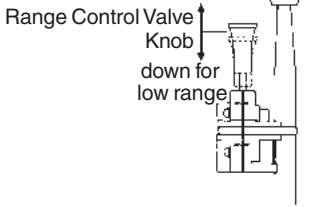

### Range Control Valve

**(A-3546)** Splitter Control Button

forward for underdrive or overdrive rearward for direct

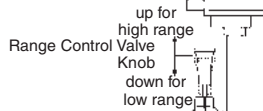

Two-Position Splitter Control Valve  
**(A-4491/4493/4494)**

### Master Control Valve

**(A-5010)**

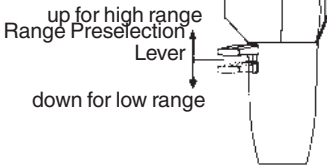

### Master Control Valve

**(A-4900)**

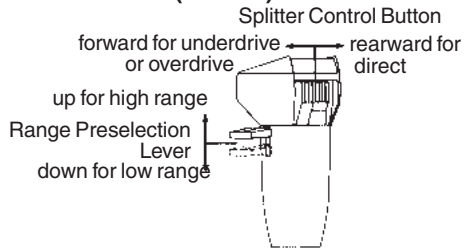

### Master Control Valve

**(A-5015)**

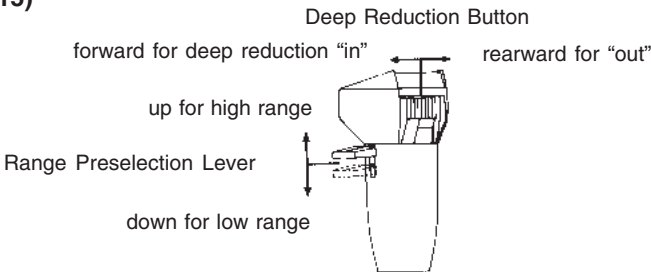

### Detailed Operating Instructions

In the following instructions, it is assumed that the operator is familiar with motor trucks and tractors equipped for stationary use of an Extended Rear Countershaft P.T.O. Unless otherwise stated, these instructions apply to all Fuller Roadranger Transmissions equipped

with the Rear Mount Countershaft P.T.O. Neutral Interlock System.

**CAUTION:** Failure to comply with the proper shifting or operating sequences may result in premature P.T.O. failure with possible damage to other components of the transmission.



## 540 Countershaft for Fuller

### To Engage P.T.O. for Stationary Operation:

1. For vehicles equipped with a 13-Speed Splitter Model Transmission only, flip the Splitter Control Button of the Splitter Control Valve/Master Control Valve A-4900 to the "Direct"/Rearward position.

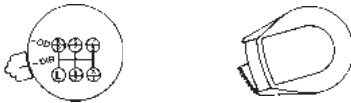

Splitter Control Button must be in the "Direct" or Rearward position.

For vehicles equipped with a Deep Reduction Model Transmission only, flip the Deep Reduction button of the Master Control Valve A-5015 to the "Out"/Rearward position.

Deep Reduction Button **must** be in the "Out" or Rearward position.



2. Bring the vehicle to a complete stop, if applicable, and disengage clutch.

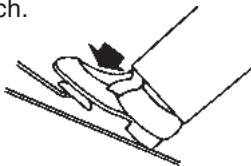

3. Set the parking brakes and move the Gear Shift Lever to the neutral position.



4. Switch the Stationary/Mobile Control to the "Stationary" position and wait for the green indicator light to appear.



**CAUTION: If green light fails to come on, do not proceed** with these operating instructions as damage to the P.T.O. and other components may result. See Trouble-Shooting.

5. With the clutch still disengaged and the green Stationary Mode Indicator Light on, move the shift lever from the neutral position to select the proper gear.



6. Move the Extended Rear Countershaft P.T.O. Control to the "In" position.

7. Slowly release the clutch pedal to engage the P.T.O. for stationary operation.

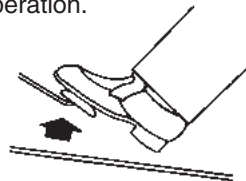

## 540 Countershaft for Fuller

### To Disengage P.T.O.:

1. Disengage clutch and wait momentarily for P.T.O. to stop rotating.

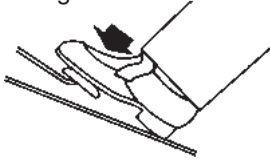

2. Move the shift lever from the in-gear selection to the neutral position.



3. Move the Extended Rear Countershaft P.T.O. Control to the "Out" position.

### To Regain Mobile Operation:

1. With the clutch still disengaged, switch the Stationary/Mobile Control to the "Mobile" position, causing the green Stationary Mode Indicator Light to go out.



**CAUTION:** If green light fails to go off, do not proceed with these operating instructions as damage to the P.T.O. and other components may result. See Trouble-Shooting.

2. It is now safe to release the clutch pedal.

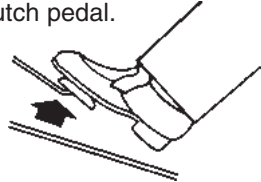

3. Release parking brakes to prepare for operating the vehicle in the mobile mode.

**CAUTION:** To avoid improper operation of the vehicle while in the mobile mode, read carefully the Driver Instructions Form that pertains to your particular model transmission. As a rule, good driving habits and proper shifting techniques will make driving easier and prevent unnecessary damage to the transmission.

A shift pattern and operating instructions decal should be in the vehicle equipped with the Fuller Rear Mount Countershaft P.T.O. Neutral Interlock System. If either decal has been misplaced or destroyed, a replacement may be obtained by writing to: Eaton Corporation, Transmission Division, Service Parts Department, Kalamazoo Plant, 222 Mosel Avenue, Kalamazoo, Michigan 49007. Please specify transmission model number when making request.

## 540 Countershaft for Spicer

### CAUTION

This vehicle is equipped with a countershaft Power Take-Off. Consult the following operating instructions before using.

#### A. To Engage on Spicer 1007, 1207, 1411, 1412, 1414, 1420 and 9505 Transmissions.

1. Disengage the vehicle clutch and stop the vehicle.
2. Set the parking brakes and place the main transmission in neutral.
3. Move the range control.
  - a. (1007 and 1207 to low position)
  - b. (1411, 1412, 1414 and 1214 to no. 1 position)
  - c. (1420 to low off highway)
4. Move the transmission neutral control valve to stationary position.
5. Move the countershaft P.T.O. air control valve to the "In" position.
6. Move the range control.
  - a. (1007 and 1207 to hi position)
  - b. (1411, 1412, 1414 and 1214 to no. 4 position)
  - c. (1420 to hi on highway position)
7. The light mounted next to the dash control valve will light when the P.T.O. is engaged.
8. Select main transmission into desired gear position.
  - a. The relative speed of the countershaft P.T.O. output shaft to engine speed can be changed by selecting different main transmission gear positions. Consult

vehicle manufacturers recommended gear position for proper P.T.O. speeds.

**Warning:** While doing this the rear range box must be kept in neutral with the brakes set or the vehicle may start to move.

9. Release the clutch. The countershaft P.T.O. will now start to rotate.

#### B. To Disengage on Spicer 1007, 1207, 1411, 1412, 1414, 1214, 1420 and 9505 Transmissions.

1. Disengage the vehicle clutch and wait for the countershaft to stop rotating.
2. Shift the main transmission into neutral.
3. Move the range control.
  - a. (1007 and 1207 to low position)
  - b. (1411, 1412, 1414 and 1214 to no. 1 position)
  - c. (1420 to low off highway position)
4. Move the countershaft P.T.O. valve to the out position.
5. Move the transmission neutral control valve to the mobile position.
6. The light mounted next to the dash control valve will be "Off" when the P.T.O. is disengaged.

#### C. To Engage on Spicer 1107, 1310, 1352, 1362, 1364, 1372, 1374, 1410, 1452, 1453, 1462 and 1463.

1. Disengage the vehicle clutch and stop the vehicle

## **540 Countershaft for Spicer**

2. Set the parking brakes and place the main transmission in neutral.
3. Move the countershaft P.T.O. air control valve to the "In" position.
4. The light mounted next to the dash control valve will light when the P.T.O. is engaged.
5. Release the clutch. The countershaft P.T.O. will now start to rotate.

### **D. To Disengage on Spicer**

- 1107, 1310, 1352, 1362, 1364, 1372, 1374, 1410, 1452, 1453, 1462, and 1463.**
1. Disengage the vehicle clutch and wait for the countershaft to stop.
  2. Move the countershaft P.T.O. air control valve to the "Out" position.
  3. The light mounted next to the dash control valve will be "Off" when the P.T.O. is disengaged.

### **IMPORTANT:**

Failure to follow proper shifting or operating sequences will result in premature P.T.O. failure with possible damage to other equipment.

## 541 Thrushaft for Fuller

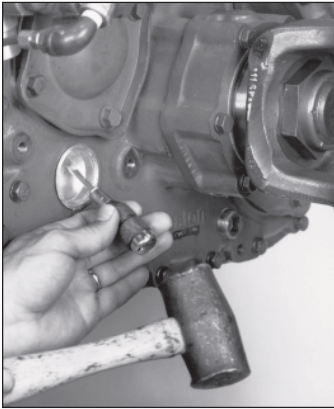

Fig. 1

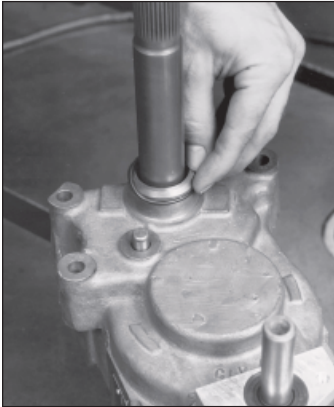

Fig. 2



Fig. 3

### Preparations

Drain the transmission oil, by removing the drain plug in the transmission rear cover. CAUTION: THE OIL MAY BE HOT.

Remove the Welsh Plug from the P.T.O. drive access hole. Fig. 1.

Lubricate the O-Ring supplied, with Parker-O-Lube.

Install the O-Ring in the groove in the P.T.O. case. Fig. 2.

### 541 Series P.T.O to the Transmission

Insert the P.T.O. input shaft into the P.T.O. drive access hole, lining up the P.T.O. dowel pin with the alignment hole in the transmission rear cover. Fig. 3.

## 541 Thrushaft for Fuller

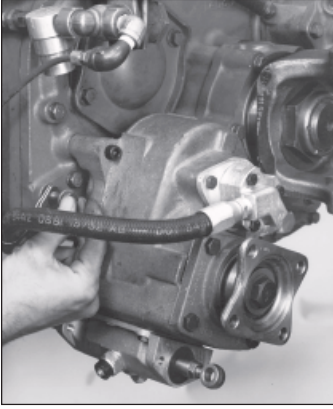

Fig. 4

Install the three cap screws (one long and two short) and torque them to 30-35 ft. lbs. Fig. 4.

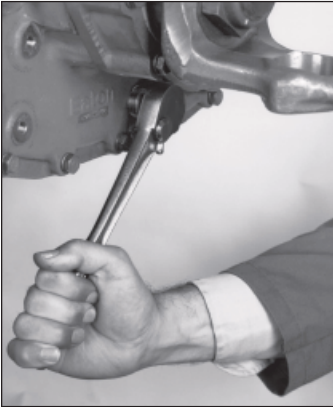

Fig. 5

### Lubrication

Install the oil strainer and the 90° elbow in the transmission rear cover drain hole. Fig. 5 & 6.



Fig. 6

## 541 Thrushaft for Fuller

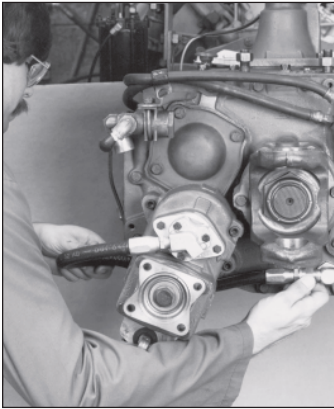

Fig. 7

Connect the P.T.O. lube hose to the 90° elbow. Connect the other end of the hose to the P.T.O. oil pump. Fig. 7.



Fig. 8

Secure the P.T.O. lube hose to the transmission rear cover, using the clamp supplied and the cap screw in the transmission rear cover. Fig. 8.

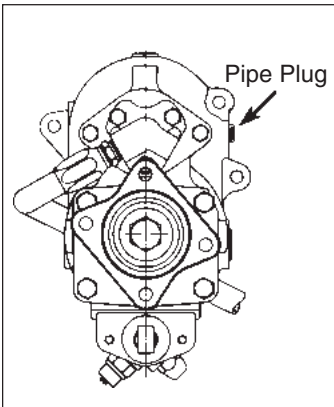

Fig. 9

Remove the pipe plug in P.T.O. case and fill the P.T.O. with transmission oil up to the pipe plug. Fig. 9. Be sure to replace the pipe plug after filling the P.T.O.

Replace the transmission oil and check the oil level at the oil level plug.

## 540- \*AK Countershaft for Volvo R5

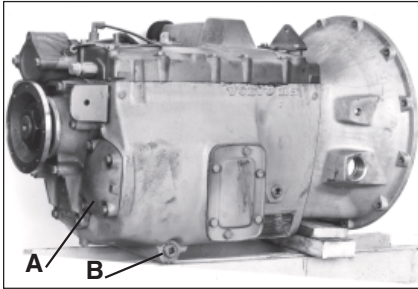

Fig. 1

Locate the countershaft cover (A) and Oil Drain plug (B) in Fig. 1.

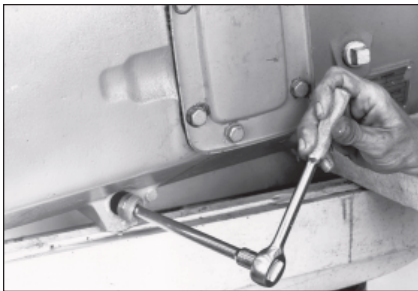

Fig. 2

Drain the transmission oil by removing the oil drain plug.  
**Note:** Use caution when draining the transmission - the oil may be hot. (Fig. 2)

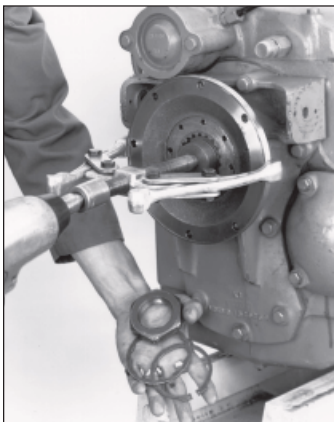

Fig. 3

Now as shown in Fig. 3 remove the Snap ring, lockwasher and nut from the transmission output shaft. Now you are ready to pull off the companion flange.



## 540- \*AK Countershaft for Volvo R5

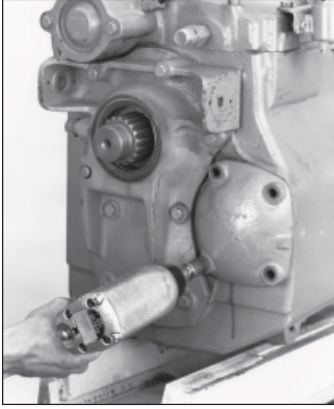

Fig. 4

Remove the four bolts holding on the countershaft cover and gasket. (Fig. 4)

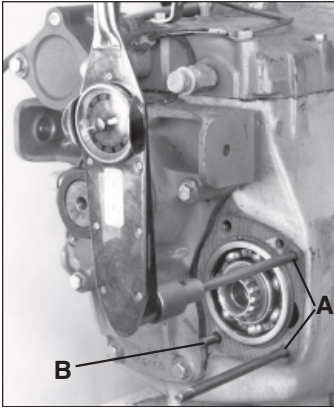

Fig. 5

Install the two 379054-83 studs (A) in the two side bolt holes. Install the short 378478-10 stud (B) in the lower left hand bolt hole as shown in Fig. 5. Then torque all three studs to 37-41 ft. lbs.

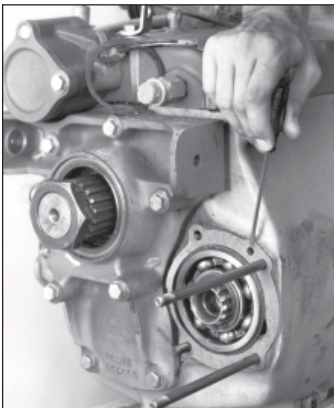

Fig. 6

Now install the 35-P-53 mounting gasket over the studs and onto the transmission. Make sure that the lube hole in the gasket is matched up with the lube hole on the transmission. (Fig. 6)

## 540- \*AK Countershaft for Volvo R5

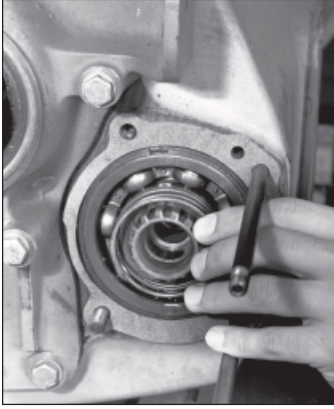

Fig. 7

Install the 37-P-53 spring from the 540-\*AK mounting kit over the countershaft extension. (Fig. 7)

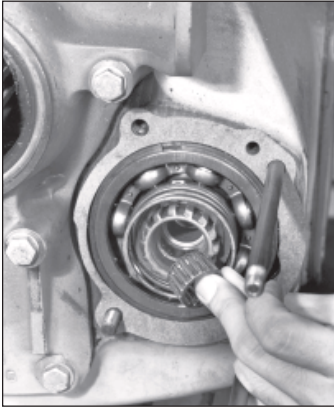

Fig. 8

Now install the roller bearing 560964 in the countershaft as shown in Fig. 8.

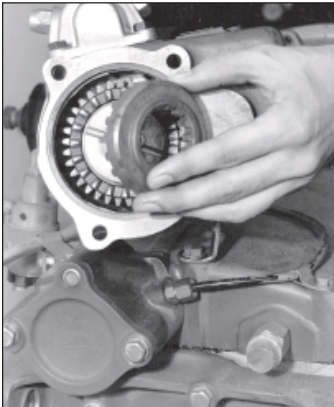

Fig. 9

Place the 31-P-76 thrust washer next to the input gear. Now place the 57-P-22 clutch in the 540- \*AK housing with its clutch teeth engaged to the sliding input gear. (Fig. 9)

## 540- \*AK Countershaft for Volvo R5

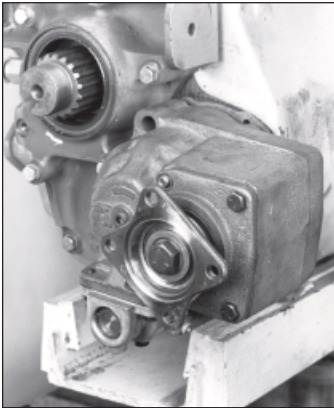

Fig. 10

Install the 540- \*AK over the studs as shown in Fig. 10.

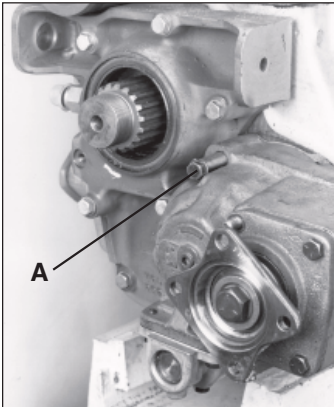

Fig. 11

Make sure the 500365-26 washer is placed first on the 378431-26 Hex Head Screw and then the 379164 cone lock sleeve is placed on. Now you can install the cap screw assembly (A) in the top left bolt hole. (Fig. 11)

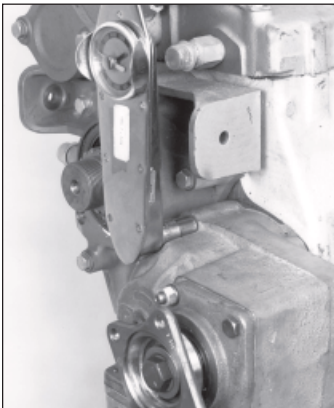

Fig. 12

Now torque the top left cap screw to 32-37 ft. lbs. (Fig. 12)

## 540- \*AK Countershaft for Volvo R5

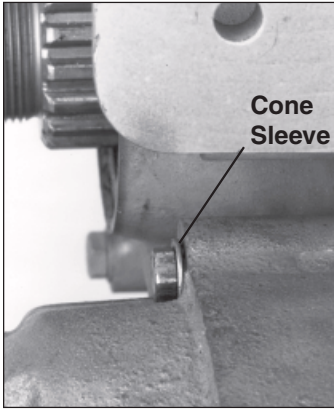

Fig. 13

**Note:** Once the 378431-26 Hex Head Screw is torqued down, the cone sleeve will be exposed. (Fig. 13)

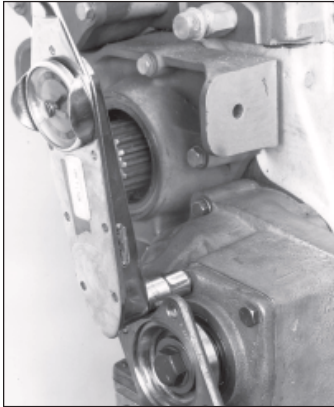

Fig. 14

Put the 500357-11 lockwasher and 501146-3 Hex Nut on the two right side studs and the lower left stud. Torque all three to 35-40 ft. lbs. (Fig. 14)

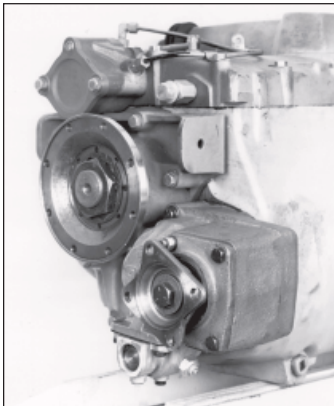

Fig. 15

Now replace the companion flange and tighten the nut until the lockwasher fits and the locking can be installed. (Fig. 15)

**Note:** Check Transmission Manufacturer for recommended installation torque.

## 540- \*AK Countershaft for Volvo R5

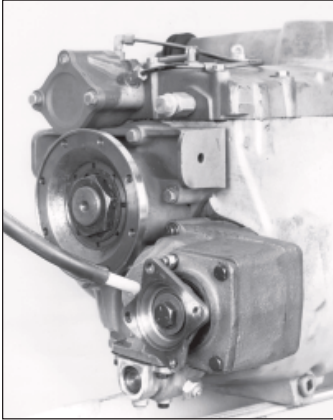

Fig. 16

Remove the 378888 pipe plug and Fill the 540-\* AK with 8 ounces (220 ML) of transmission fluid. Remember to replace the pipe plug after filling the counter-shaft P.T.O. (Fig. 16)

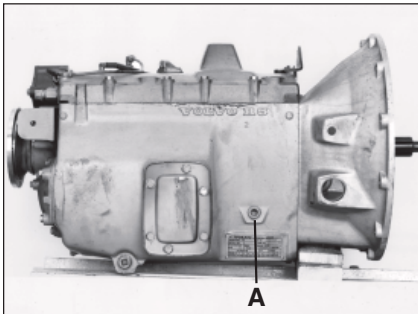

Fig. 17

Remember to fill the transmission with oil and check the oil level within the transmission at the oil level plug (A) for proper oil level. (Fig. 17)

Install two 378360 male connectors in air shift cover and plumb air circuit per sketch as shown on [page 42](#).

## 540- \*AL Countershaft for Volvo R6

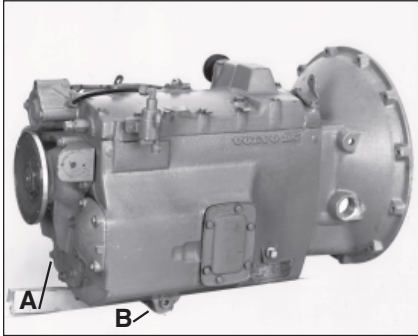

Fig. 1

Locate the countershaft cover (A) and Oil Drain Plug (B) in Fig. 1.

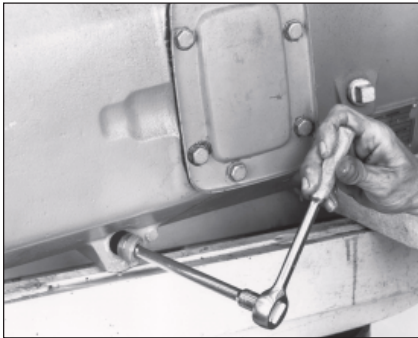

Fig. 2

Drain the transmission oil by removing the oil drain plug. (Fig. 2) **Note:** Use caution when draining the transmission as the oil may be hot.

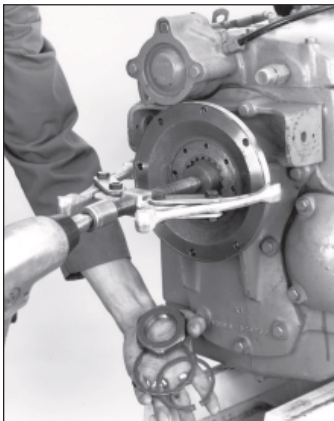

Fig. 3

Now as shown in Fig. 3 remove the Snap ring, lockwasher and nut from the transmission output shaft. Now you are able to pull off the companion flange.



## 540- \*AL Countershaft for Volvo R6

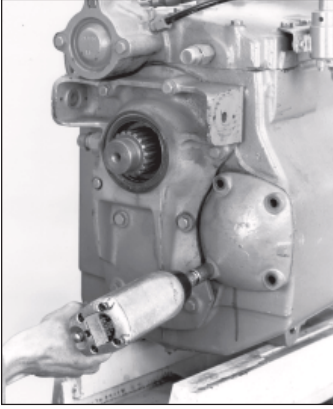

Fig. 4

Remove the four bolts holding on the countershaft cover and gasket. (Fig. 4)

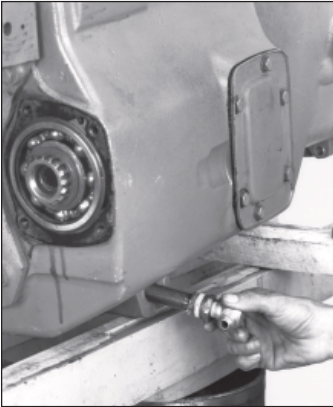

Fig. 5

Install the 90° elbow and oil strainer that is furnished in the mounting kit for the 540-\* AL countershaft. (Fig. 5)

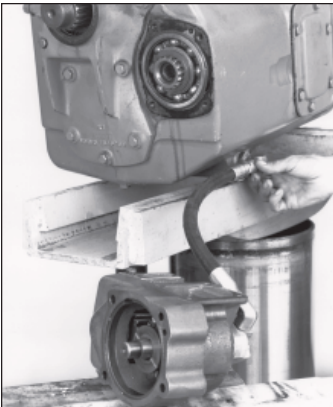

Fig. 6

Support the countershaft and install the lube line onto the 90° elbow. (Fig. 6)

## 540- \*AL Countershaft for Volvo R6

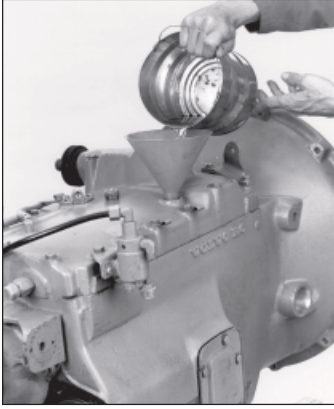

Fig. 7

To prime the lube pump place the P.T.O. below the level of the 90° elbow, fill the transmission with 4 gallons (15 liters) of oil. Remember to replace the fill plug. (Fig. 7)

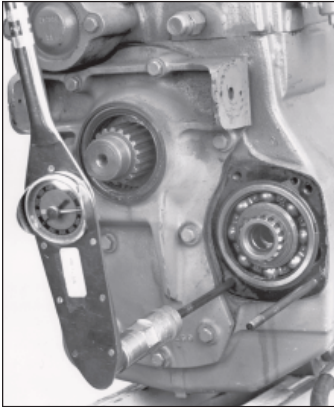

Fig. 8

Install the two studs (A) in the lower bolt holes as shown in Fig. 8. Then torque the studs to 37-41 ft. lbs.

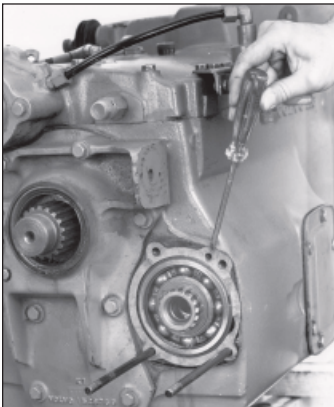

Fig. 9

Now install the 35-P-55 mounting gasket over the studs and onto the transmission. Make sure that the lube hole in the gasket is matched up with the lube hole on the transmission. (Fig. 9)



## 540- \*AL Countershaft for Volvo R6

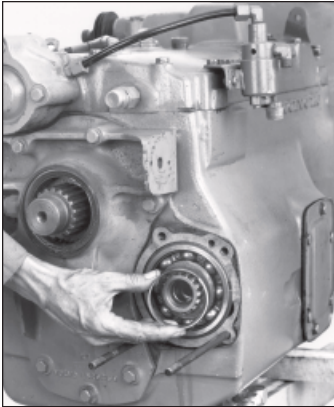

Fig. 10

Install the 37-P-54 spring from the 540- \*AL mounting kit over the countershaft extension. (Fig. 10)

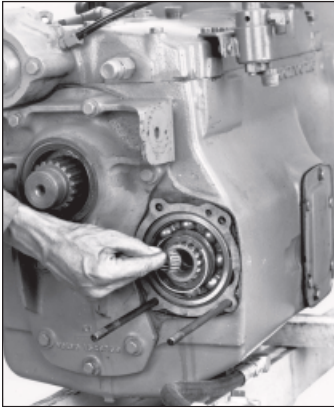

Fig. 11

Now install the roller bearing 560964 in the countershaft as shown in Fig. 11.

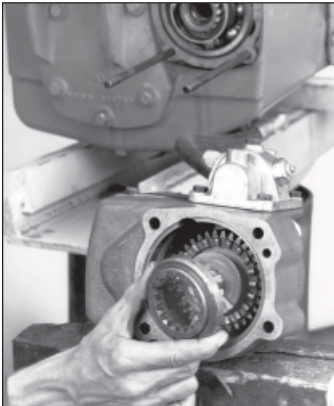

Fig. 12

Place the 31-P-76 thrust washer next to the input gear. Now place the 57-P-23 clutch in the 540- \*AL housing with its clutch teeth engaged to the sliding input gear. (Fig. 12)

## 540- \*AL Countershaft for Volvo R6

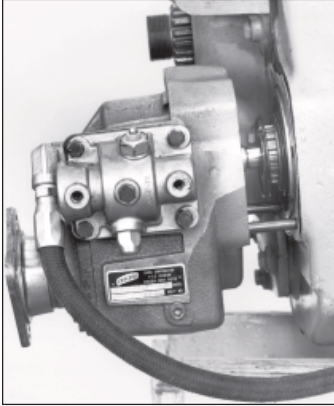

Fig. 13

Install the 540- \*AL over the studs as shown in Fig. 13.

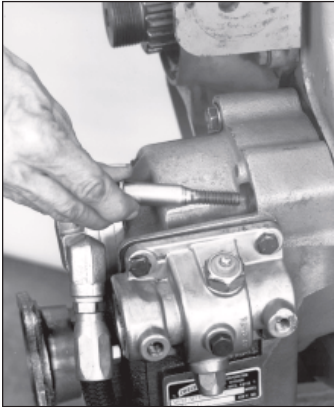

Fig. 14

Make sure the 500365-26 washer is placed first on the 378431-26 Hex Head Screw and then the 379164 cone lock sleeve is placed on. Now you can install the capscrew assembly in the Top two bolt holes. (Fig. 14)

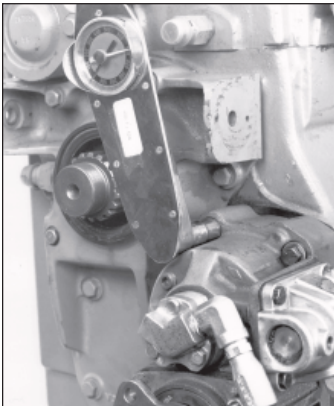

Fig. 15

Now the top two capscrews should be torqued to 32-37 ft. lbs. (Fig. 15)

## 540- \*AL Countershaft for Volvo R6

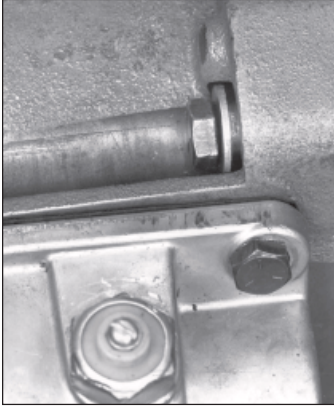

Fig. 16

**Note:** Once the 378431-26 Hex Head Screws are torqued down, the cone sleeve will be exposed as shown in Fig. 16.

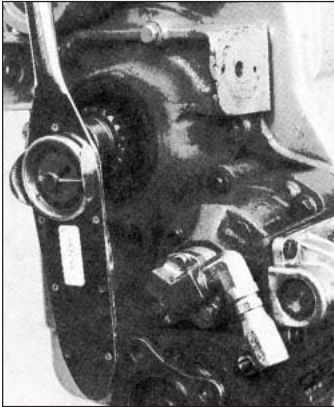

Fig. 17

Place the 500357-11 lockwasher and 501146-3 Hex Nut on the two lower studs. Torque both nuts to 35-40 ft. lbs.

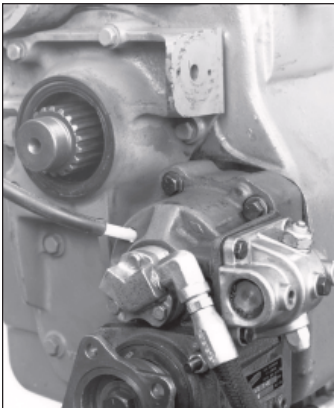

Fig. 18

## 540- \*AL Countershaft for Volvo R6

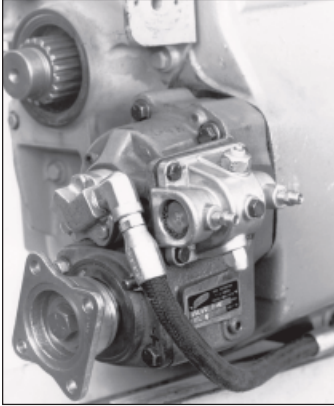

Fig. 19

Install two 378360 male connectors in air shift cover and plumb air circuit per sketch. (Fig. 19)

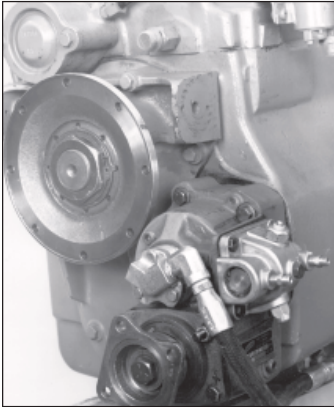

Fig. 20

Now replace the companion flange and tighten the nut until the lockwasher fits and the locking can be installed. (Fig. 20)

**Note:** Check Transmission Manufacturer for recommended installation torque.

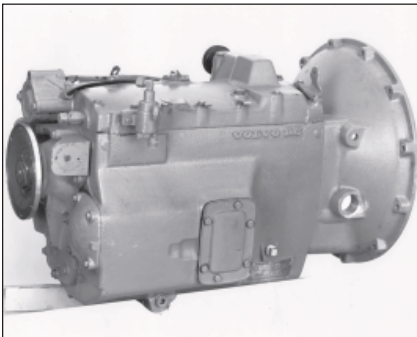

Fig. 21

Remember to check the oil level within the transmission at the oil level plug (A) for proper oil level. (Fig. 21)

## 540 Countershaft for Fuller



1. Remove drain plug and drain oil from transmission. After oil is all drained out, immediately re-install drain plug.

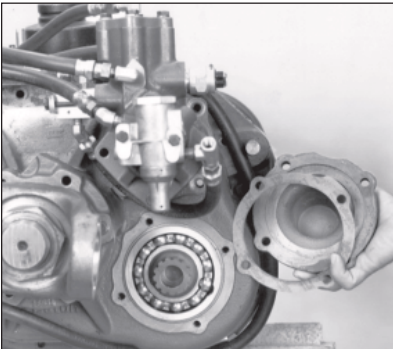

2. Remove extended countershaft bearing cover and gasket from transmission.

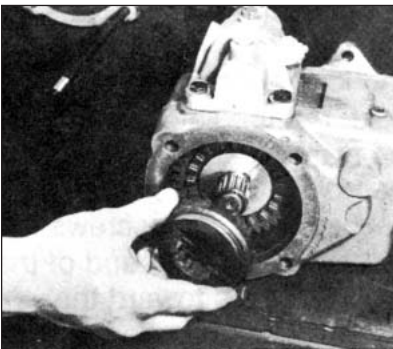

3. Place 57-P-17 P.T.O. clutch into 510 housing with its clutch teeth engaged to the 57-P-16 sliding clutch in the P.T.O

## 540 Countershaft for Fuller

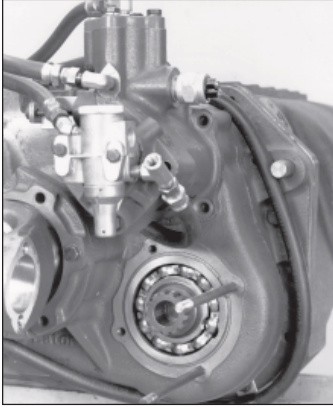

- Next install two (2) studs into transmission ("AA and "AQ" require 3/8" x 7.00" studs and "AD" and "AE" require 3/8" x 1.75" studs). These two studs can go in two (2) different patterns depending on how you want shifter cover on P.T.O. to be positioned. Torque studs to 30-37 ft. lbs. Then place gasket over studs.

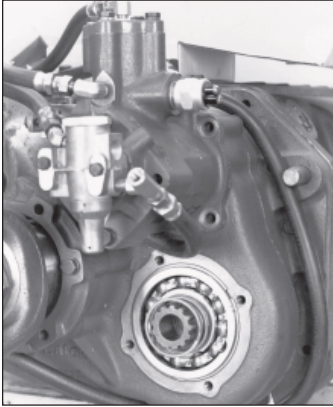

- Install spring over extended countershaft of transmission. Make sure the spring is installed against the bearing in the transmission.
- Now install the P.T.O. to the transmission. Put the two nuts and lock washers on the studs. Next, put the flat washers on the two (2) capscrews, and then place the two cone sleeves on the capscrews. Make sure tapered end of the cone sleeve is toward the transmission. Torque the nuts to 30-37 ft. lbs. and the hex capscrews to 30-37 ft. lbs.

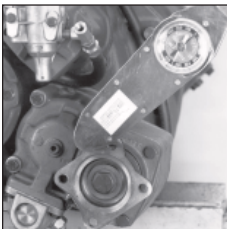
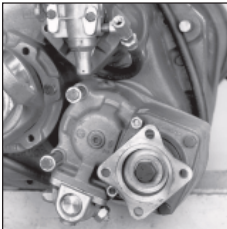

**Note:** Make sure the spring, clutch gear, and gasket remain in place.

**Note:** It may be necessary to rotate clutch splines in 540 P.T.O. to align them with the transmission splines.



## 540 Countershaft for Fuller

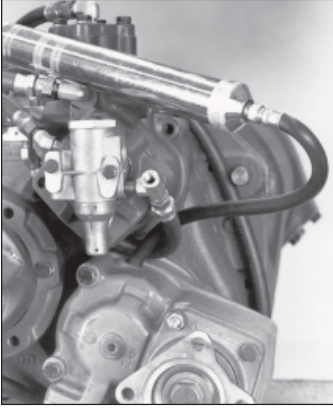

7. The 540 P.T.O. should be filled with oil. After the initial filling the P.T.O. will be lubricated with oil from the transmission.

**Note:** Refill transmission to the proper oil level after filling P.T.O.

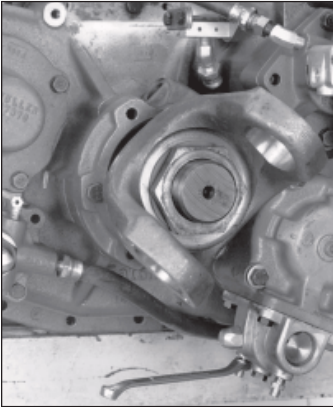

8. Install two (2) 378360 male air fittings to the P.T.O. air shift cover and plumb air circuit per sketch.

## 540 Countershaft for Spicer

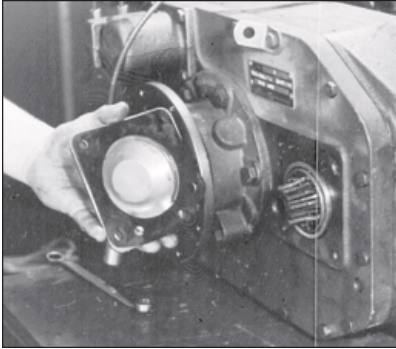

2. Install the two 379054-83 studs. Torque to 32-37 ft. lbs.

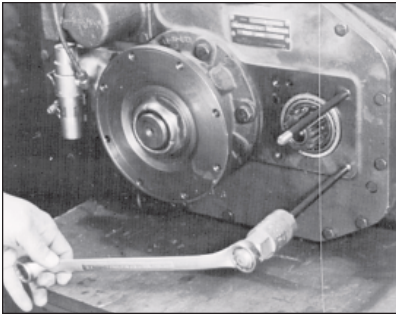

5. Mesh 57-P-17 clutch with input gear face in 540 housing.

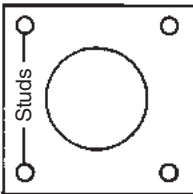

Left Side: Shift  
Cover up

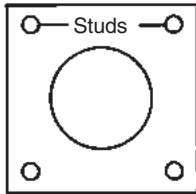

Right Side: Shift  
Cover to Right

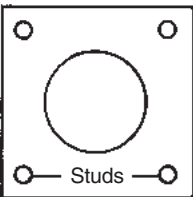

Left Side: Shift  
Cover to Left

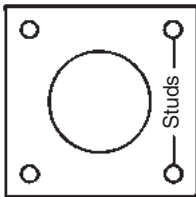

Right Side: Shift  
Cover Down



## 540 Countershaft for Spicer

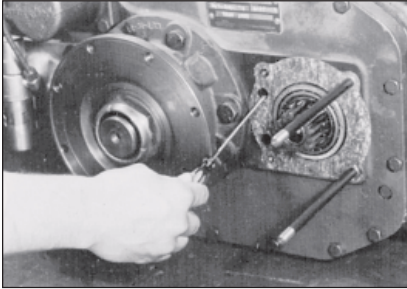

Step A 22-P-61 Gasket

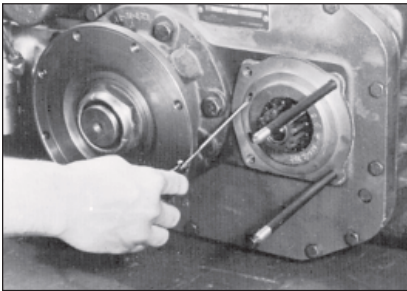

Step B Bearing Cap

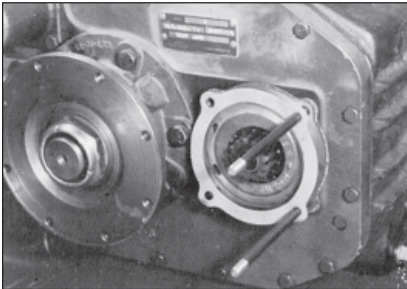

Step C 22-P-62 Gasket

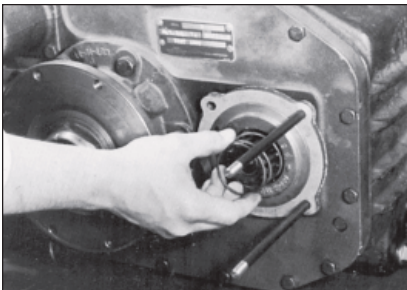

- Place the bearing cap gasket (see chart below), bearing cap, and 22-P-62 housing gasket on transmission in order shown, in steps A, B and C.

Input Designation	Bearing Cap Gasket
AB	22-P-61
AC	22-P-61
AF	22-P-68
AG	22-P-61
AH	22-P-68

**Note:** The lube holes MUST line up with the transmission holes as shown.

- Install spring over counter shaft extension.

Input Designation	Bearing Cap Gasket
AB	37-P-45
AC	37-P-46
AF	37-P-52
AG	37-P-45
AH	37-P-52

**Note:** Make sure spring is installed against the bearing of the transmission.

Input Designation	Bearing Cap Gasket
AB	21-P-351
AC	21-P-352
AF	21-P-378
AG	21-P-351
AH	21-P-378

## 540 Countershaft for Spicer

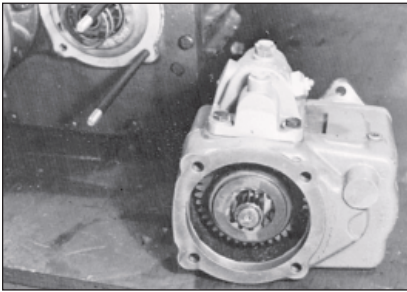
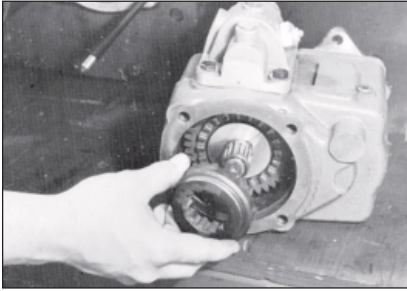

6. Install the 540 P.T.O. over the extended studs. The studs go through the two holes within the bearing cap of the output shaft. (see step #2 for locating studs)

Possible installations:

Left side: shift cover up or left  
Right side: shift cover down or right

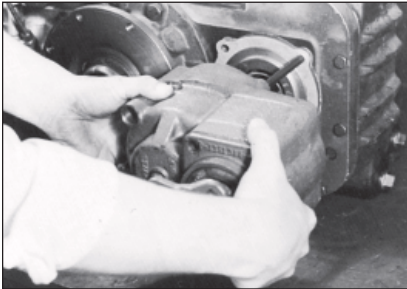

**Note:** When mounting the P.T.O. on the left side, the transmission regulator filter assembly, 313042, may need to be relocated. Make sure to install it in the vertical position with its drain down as it was installed originally. As shown in bottom photo.

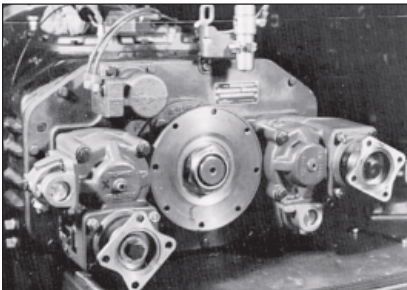

## 540 Countershaft for Spicer

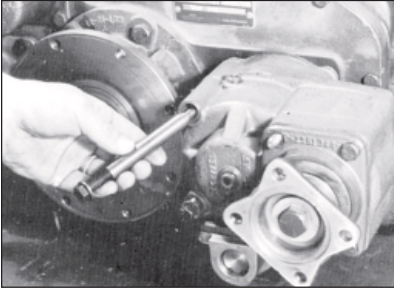

7. Slide 378448-14 bolts thru the 379164 cone sleeves. Place both assemblies in 540 P.T.O.

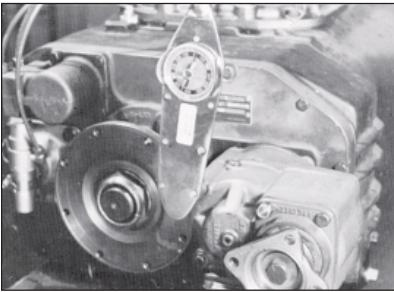

8. Install 500357-11 lockwashers and 501146-3 nuts on two exposed 379054-83 studs. Torque 378448-14 bolts to 32-37 ft. lbs. (4.43-5.12 kg-M) and 501146-3 nuts to 35-40 ft. lbs. (4.84-5.53 kg M).

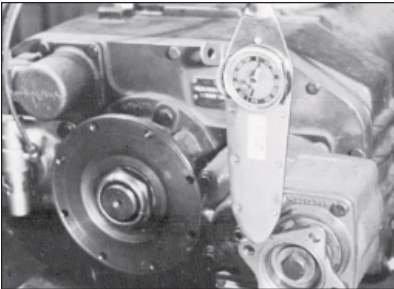

## 540 Countershaft for Spicer

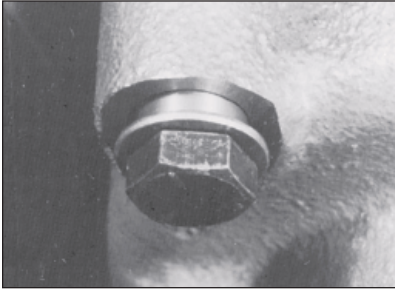

9. Once the 378448-14 bolts are torqued down, the cone sleeve will be exposed as shown.

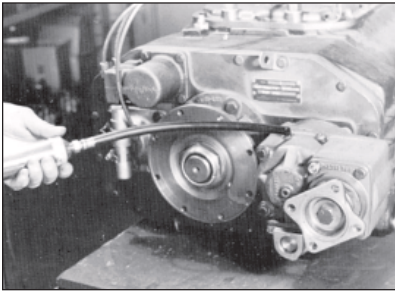

10. Add same lube as used in mating transmission per the following amounts per position. (Shown in the chart at bottom of this page.)

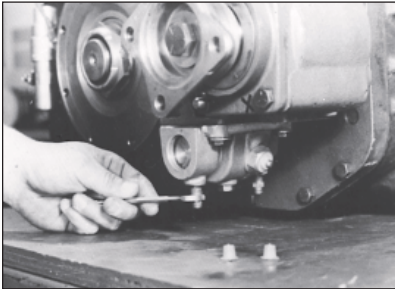

11. Install the two 379042 male connectors in air shift cover and plumb air circuit per included sketch.

Transmission Side	P.T.O. Shift Cover Left	P.T.O. Shift Cover Right	P.T.O. Shift Cover Up	P.T.O. Shift Cover Down
Left	16 ozs. (450 ML)	—	12 ozs (350 ML)	—
Right	—	16 ozs (450 ML)	—	12 ozs. (350 ML)

## Air Shift for 540/541 Series

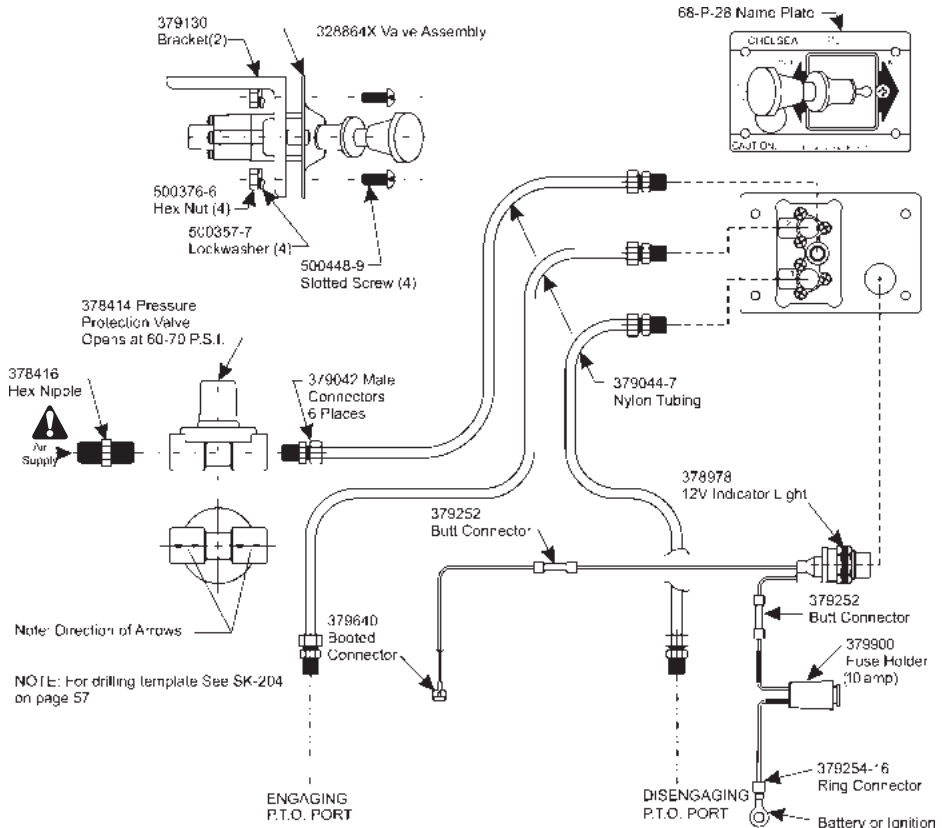

**Warning:** Connect directly to air supply. Do not use tubing between air supply and pressure protection valve.

**Caution:** When installing nylon tubing avoid sharp angles, exhaust and manifold systems.

**Important:** When this installation is used on vehicles with automatic transmissions, the P.T.O. drive gear must be stopped before shifting.

**Note:** Tube nut is reusable as long as nylon tubing is not removed from the tube nut.

Template for control plate [on page 57](#).







**1007-2A,-2B, -3A, 1207-2B, -2D and 3A Air Plumbing  
Diagrams for Spicer (SK-233 Rev B)**

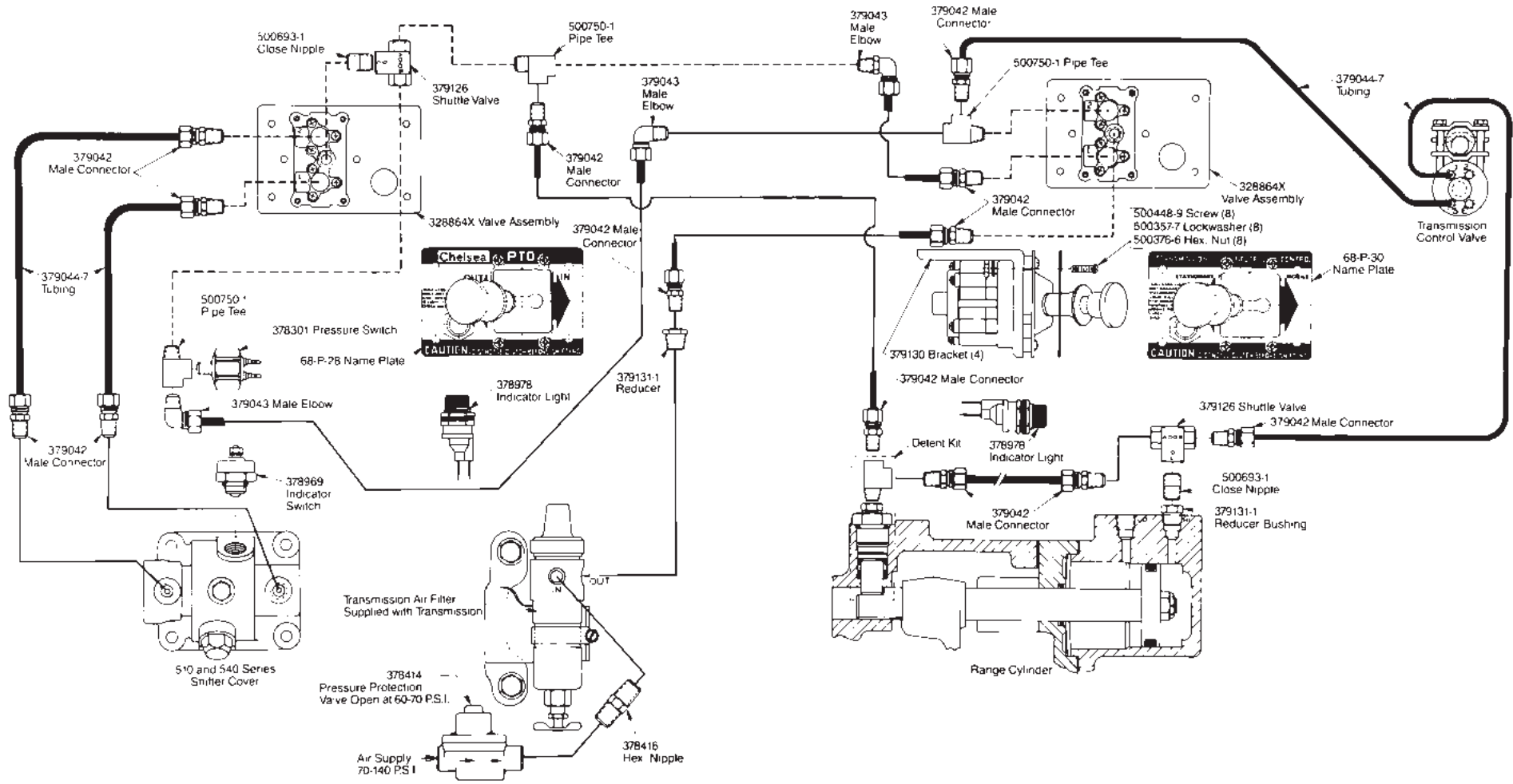

Caution: When installing nylon tubing avoid sharp angles, exhaust and manifold systems.

Note: For Drilling template See pages 57 and 58.



## Cable Control Installation Instructions \*

1. Find a suitable area on the dash to install the cable control (328346-10X) and the control plate (68-P-18) indicator light.

Optional Location: As an option the control cable and knob can be located through floor. Using this option the control plate and indicator light should still be located on dash, in close proximity.

**NOTE:** The location of the cable control and the control plate should be as close to each other as possible and easily accessible by the driver or operator, but should not be an obstacle to driver movement nor interfere with other controls, instruments, or equipment.

2. **CAUTION:** Before drilling any holes, make sure there is adequate room on both sides through dash wall, drill a 1/2" (.5") diameter hole for the control cable. [1]
3. Install the control cable on the dash using the hex nuts supplied with the cable. The knob can then be screwed into place [2]. The length of cable can then run through the firewall and back to the P.T.O. —making sure it is kept away from the exhaust, moving parts, etc.

**NOTE:** Do not kink the cable. In order for the cable to operate properly, there can be no bends smaller than 6 inch radius. Total bends in the cable should not exceed 360° (example - four 90° bends in cable).

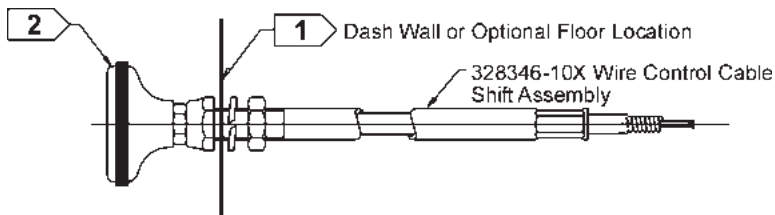

4. Using the template found on page 55 (SK-168) drill the necessary holes for the control plate-indicator light.
5. Install the control plate (68-P-18) stick on decal and indicator light on the dash using the hardware supplied in the 328751-1X installation kit (Fig. 25).

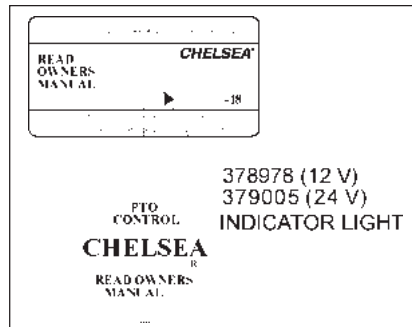

Fig. 25

\* All six bolt wire shifts with the exception of the reversible, dual shift units, and some gear boxes.

## Cable Control Installation Instructions \* (Continued)

- Determine from which direction the cable must come in order for the unit to be disengaged when the knob is all the way in.

**NOTE:** The shifter must always be installed in the following manner:

\* CABLE IN: P.T.O. DISENGAGED(6A): OUT OF GEAR POSITION  
CABLE OUT: P.T.O. ENGAGED(6B): IN GEAR POSITION

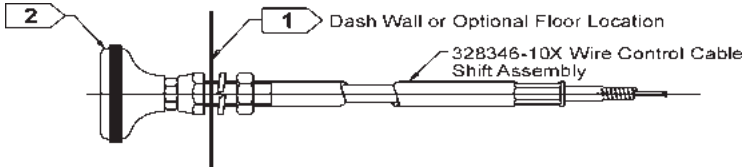

\* The wire shift cable should be installed so that when the cable (knob) is shifter, to the disengaged mode.

- Install the wire control bracket found in either the 328380X or 328380-1X wire control parts bag. [7]

- Line the cable up with the wire control bracket and shifter lever (disengaged position) on the P.T.O. cover assembly [8]

**NOTE:** It may be necessary to change the position of the shifter lever on the P.T.O. To do this, remove the shifter cover from the unit. This will prevent the possible loss of the poppet and/or spring into the transmission if the shifter post assembly should be pushed through the cover when reinstalling the lever.

- Shift the P.T.O. to the engaged position to see how much of the cable casing must be cut to allow the lever enough travel to shift in and out completely. The casing need only go just beyond the bracket, whereas, the wire must be long enough to go through the swivel pin in the shifter lever. [9]

**NOTE:** In some instances the cable control may not be long enough. Chelsea has available four longer lengths than the standard ten-foot cable. These come in five foot increments (i.e., 328346-15X = 15-foot cable).

- When the length of the casing has been determined, pull the wire back through until the case can be cut without cutting the wire. Use a hacksaw or heavy pair of side cutters to cut the casing.

**NOTE:** The cable can be held by a bench vise as long as the jaws are not tightened to the point where the case mushrooms. If a vise is not accessible, a pair of vise grips will do the job.

\* All six bolt wire shifts with the exception of the reversible, dual shift units, and some gear boxes.

### Cable Control Installation Instructions \* (Continued)

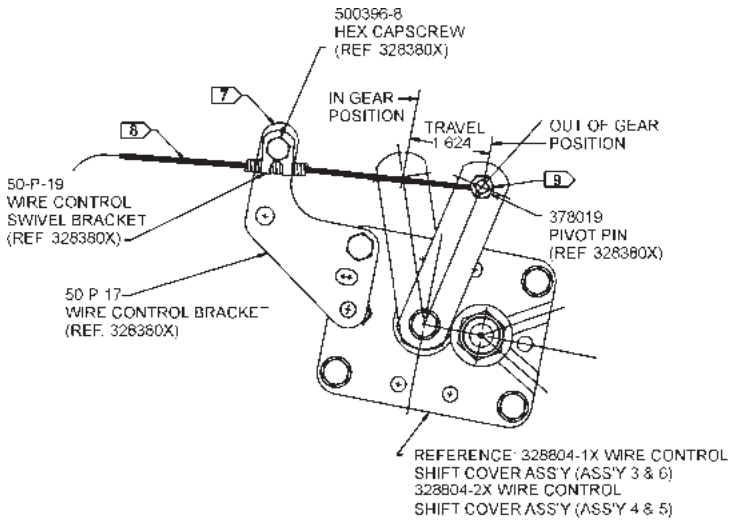

11. Push the wire back through and install the cable using the hardware from the previously mentioned wire control parts bag (328380X).
12. Cut the excess wire after the cable casing and wire have been installed and tightened.

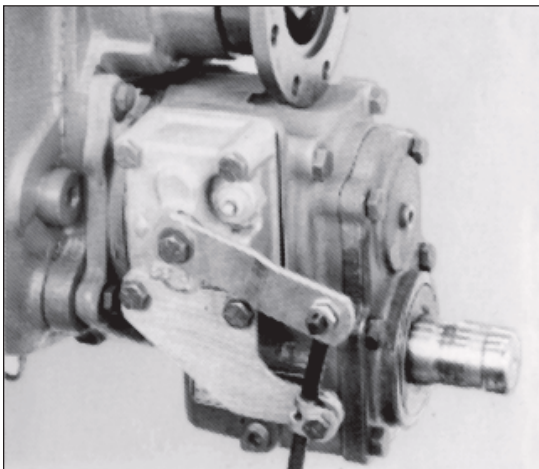

\* All six bolt wire shifts with the exception of the reversible, dual shift units, and some gear boxes.

## Cable Control Installation Instructions \* (Continued)

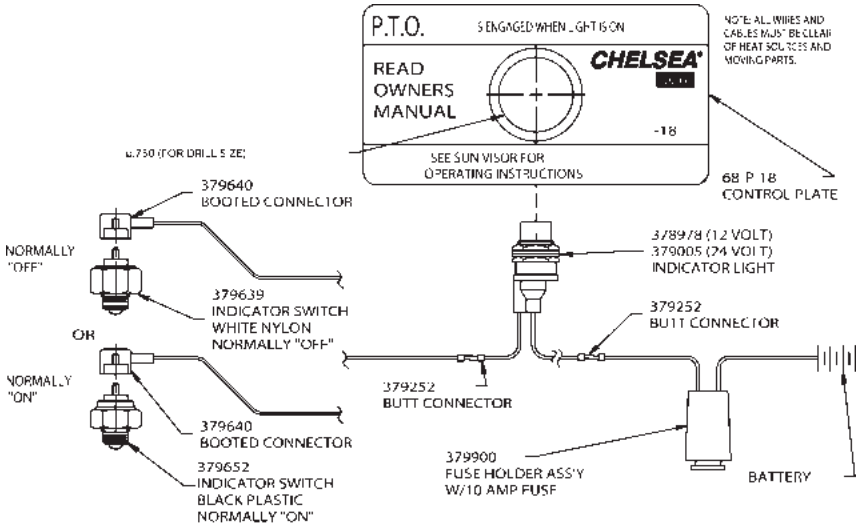

### Indicator Light Installation Sketch (SK-286)

**CAUTION:** Indicator switches are capable of 0.5 amps maximum.

13. Shift the P.T.O. to insure enough casing has been removed to allow full gear engagement.
14. Install the wiring for the indicator light using the schematic above (SK-286).

**NOTE:** Check both the cable and indicator light wires to be certain that they are not near the exhaust system or any moving parts. Carefully fasten to stationary parts of the vehicle if necessary.

15. Shift the P.T.O. The following should be adhered to:  
15A. CABLE IN: P.T.O. DISENGAGED: LIGHT OUT  
15B. CABLE OUT: P.T.O. ENGAGED: LIGHT ON

**NOTE:** The P.T.O. should be checked for continuity as per the instructions in this manual.

**NOTE:** Cable must be rigidly mounted-possibly to the transmission within 12-24" of the P.T.O.

\* All six bolt wire shifts with the exception of the reversible, dual shift units, and some gear boxes.

## **Cable Control Installation Instructions (Continued) (Reversibles, dual shift units, and some gear boxes)**

1. Use steps #1-#5 from previous instructions.
2. In step #6 the cable can come from either direction since the P.T.O. will always be engaged when all the way in or out.
3. Follow step #7 and #8.
4. In step #9 shift the P.T.O. from forward to reverse or vice versa to determine the amount of travel needed and the length of casing to be cut.
5. Follow step #10-#14.
6. Step #15 will show the following:

CABLE IN: P.T.O. ENGAGED: LIGHT ON  
CABLE OUT (1st position):  
P.T.O. DISENGAGED: LIGHT OUT  
CABLE OUT (2nd position):  
P.T.O. ENGAGED: LIGHT ON

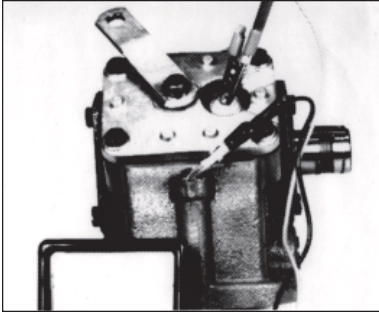

Fig. 1

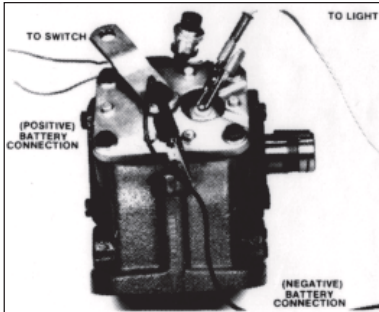

Fig. 2

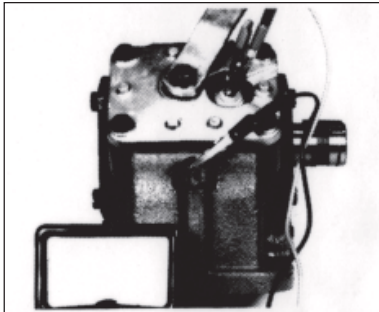

Fig. 3

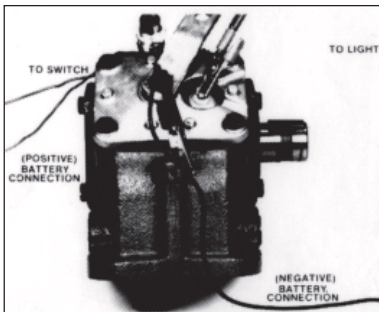

Fig. 4

In order to insure that the switch is functioning properly, the following procedure can be used with the unit on a bench, or installed.

1. Use a continuity checker, battery type, either meter or light. Attach one (1) probe to the screw on the 378969 or 379110 Indicator Switch.

**NOTE:** Make sure 378969 and 379110 Indicator Switches, in the P.T.O. shifter or housing, are torqued to 10-15 ft. lbs. (1.38-2.07 kg meters).

2. With the other probe, make contact with the shifter cover or housing (see Figs. #1 & 2).
3. Actuate shifting device and the meter or light\* should be actuated when P.T.O. gear is engaged (see Figs. #3 & 4).
4. Shift unit out of gear and the meter or light\* should return to normal as shown (see Figs. #1 and 2).

This test procedure can be used to check Chelsea wire, lever, and air shifter covers, although an air source would be necessary for the latter.

\*If a meter is not available the light in the 328751X can be used (see Figs. #2 & 4). A six volt battery is all that is necessary for a power source.

### Indicator Light Installation of Wire and Lever Control

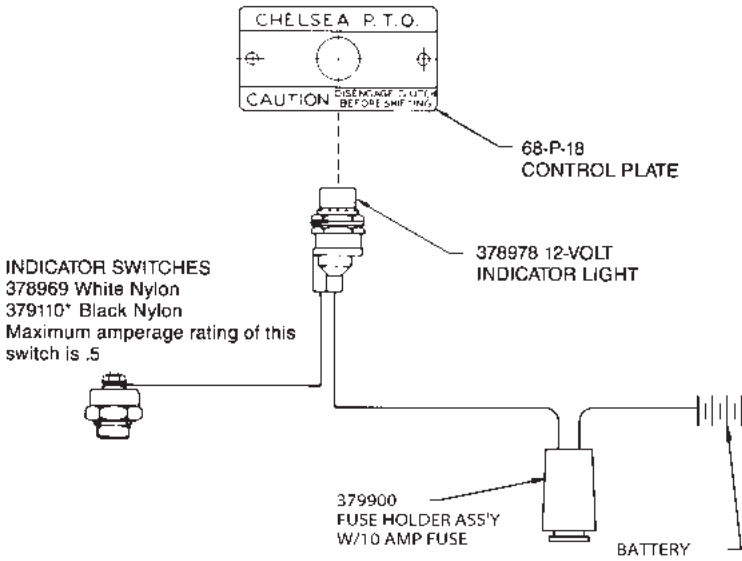

### Indicator Light 68-P-18

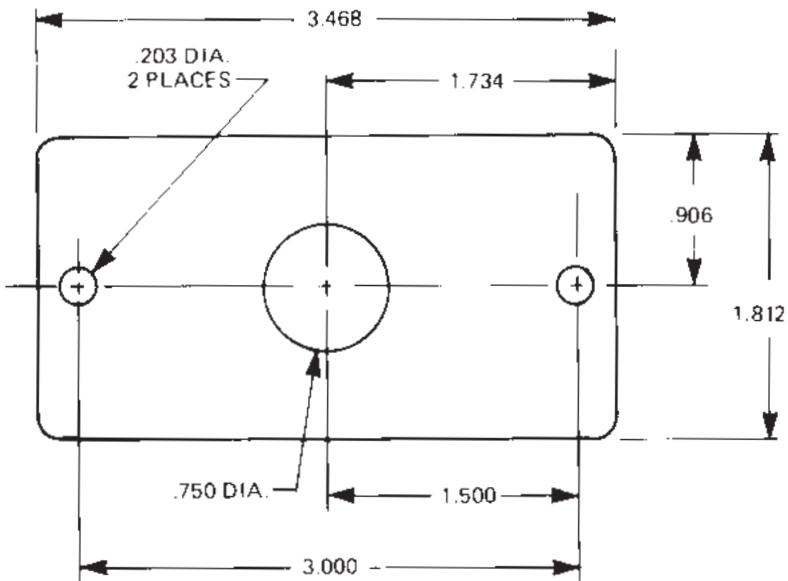

### Shift Valve and Light 68-P-27

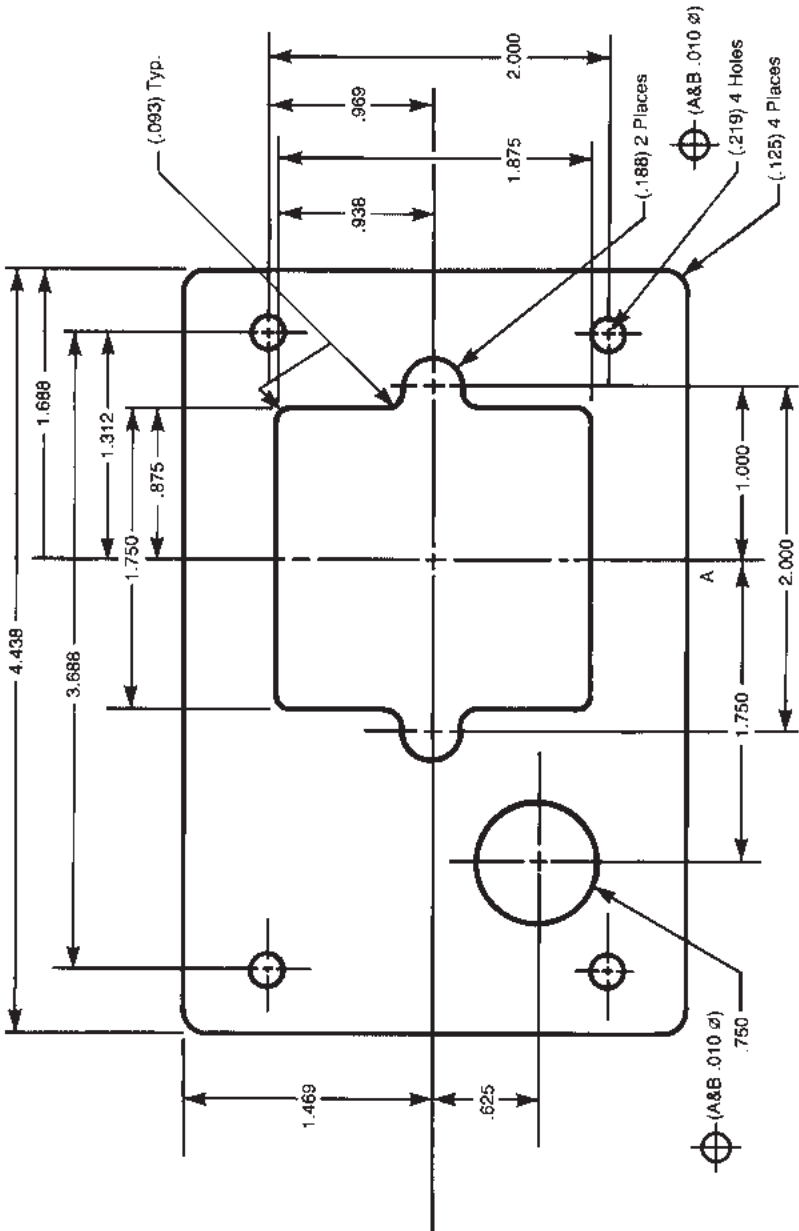



### Shift Valve and Light 68-P-28

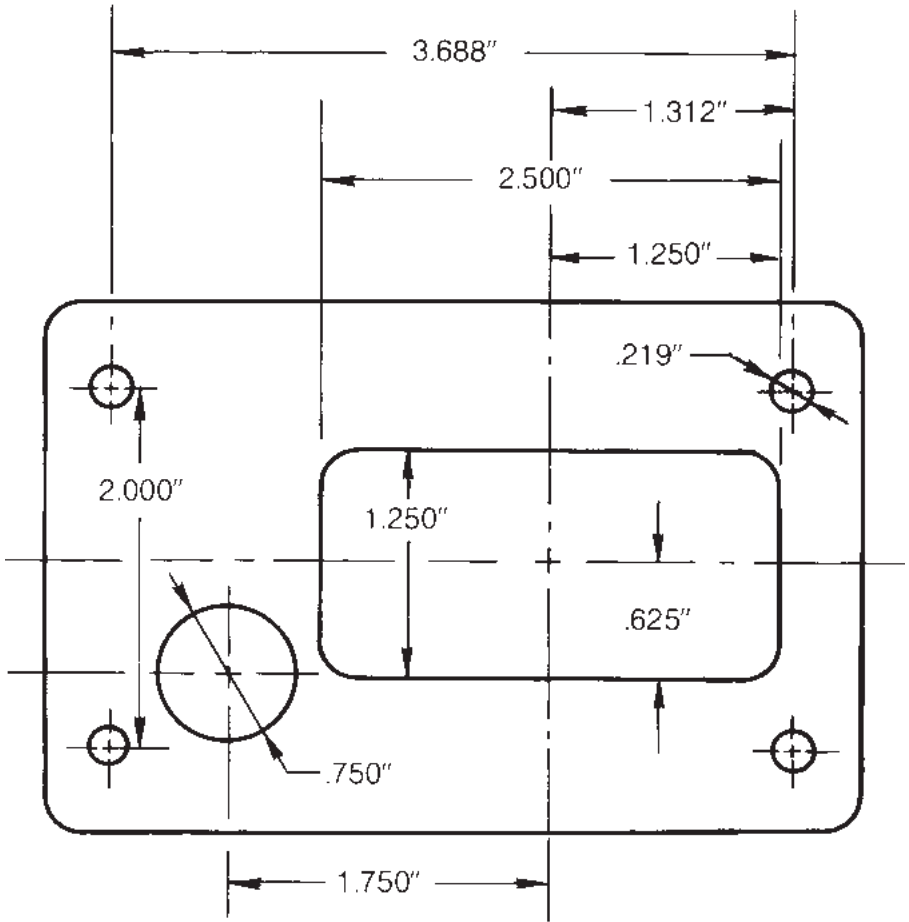

Air Shift & Indicator Light 68-P-30

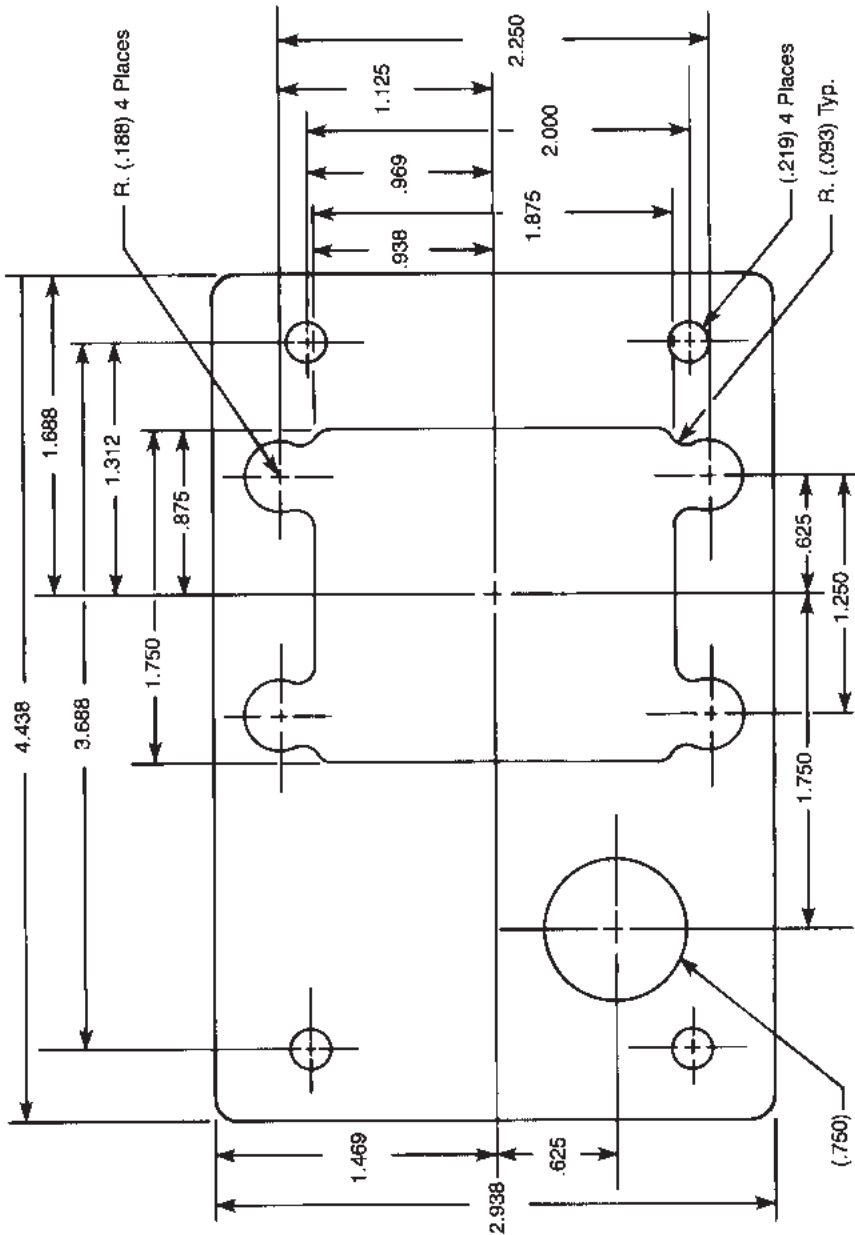

## Power Take-Off Maintenance

Due to the normal and sometime severe torsional vibrations that Power Take-Off units experience, operators should follow a set maintenance schedule for inspections. Failure to service loose bolts or Power Take-Off leaks could result in potential auxiliary Power Take-Off or transmission damage.

Periodic P.T.O. MAINTENANCE is required by the owner/operator to ensure proper, safe and trouble free operation.

**Daily:** Check all air, hydraulic and working mechanisms before operating P.T.O. Perform maintenance as required.

**Monthly:** Inspect for possible leaks and tighten all air, hydraulic and mounting hardware, if necessary. Torque all bolts, nuts, etc. to Chelsea specifications. Insure that splines are properly lubricated, if applicable. Perform maintenance as required.

With regards to the direct mounted pump splines, the P.T.O. requires the application of a specially formulated anti-fretting, high pressure, high temperature grease. The addition of the grease has been proven to reduce the effects of the torsional vibrations, which result in fretting corrosion on the P.T.O. internal splines as well as the pump external splines. Fretting corrosion appears as a "rusting and wearing" of the pump shaft splines. Severe duty applications, which require long P.T.O. running times and high torque may require more frequent regreasing. Applications such as Utility Trucks that run continuously and are lightly loaded also require frequent regreasing due to the sheer hours of running time. It is important to note that service intervals will vary for each and every application and is the responsibility of the end user of the product. Chelsea also recommends that you consult your pump owners manuals and technical services for their maintenance guidelines. Fretting corrosion is caused by many factors and without proper maintenance; the anti-fretting grease can only reduce its effects on components.

Chelsea offers the grease to our customers in two packages. The first is a 5/8 fluid ounce tube (379688), which is included with every applicable P.T.O., and the second is a 14-ounce grease cartridge (379831). Chelsea also offers greaseable shafts for most all output designators.

**Warranty:** Failure to comply entirely with the provisions set forth in the appropriate Owner's Manual will result in voiding of ALL Warranty consideration.

## Offer of Sale

The items described in this document and other documents or descriptions provided by Parker Hannifin Corporation, its subsidiaries and its authorized distributors are hereby offered for sale at prices to be established by Parker Hannifin Corporation, its subsidiaries and its authorized distributors. This offer and its acceptance by any customer ("Buyer") shall be governed by all of the following Terms and Conditions. Buyer's order for any such items, when communicated to Parker Hannifin Corporation, its subsidiary or an authorized distributor ("Seller") verbally or in writing, shall constitute acceptance of this offer.

**1. Terms and Conditions of Sale:** All descriptions, quotations, proposals, offers, acknowledgments, acceptances and sales of Seller's products are subject to and shall be governed exclusively by the terms and conditions stated herein. Buyer's acceptance of any offer to sell is limited to these terms and conditions. Any terms or conditions in addition to, or inconsistent with those stated herein, proposed by Buyer in any acceptance of an offer by Seller, are hereby objected to. No such additional, different or inconsistent terms and conditions shall become part of the contract between Buyer and Seller unless expressly accepted in writing by Seller. Seller's acceptance of any offer to purchase by Buyer is expressly conditional upon Buyer's assent to all the terms and conditions stated herein, including any terms in addition to, or inconsistent with those contained in Buyer's offer. Acceptance of Seller's products shall in all events constitute such assent.

**2. Payment:** Payment shall be made by Buyer net 30 days from the date of delivery of the items purchased hereunder. Amounts not timely paid shall bear interest at the maximum rate permitted by law for each month or portion thereof that the Buyer is late in making payment. Any claims by Buyer for omissions or shortages in a shipment shall be waived unless Seller receives notice thereof within 30 days after Buyer's receipt of the shipment.

**3. Delivery:** Unless otherwise provided on the face hereof, delivery shall be made F.O.B. Seller's plant. Regardless of the method of delivery, however, risk of loss shall pass to Buyer upon Seller's delivery to a carrier. Any delivery dates shown are approximate only and Seller shall have no liability for any delays in delivery.

**4. Warranty:** Seller warrants that the items sold hereunder shall be free from defects in material or workmanship for a period of: (A) All Power Take-Off units one (1) year from date of installation. (B) Except 267, 277, 278, 242, 244, 245, 250, 251 and 859 series two (2) years from date of installation.

**THIS WARRANTY COMPRISES THE SOLE AND ENTIRE WARRANTY PERTAINING TO ITEMS PROVIDED HEREUNDER. SELLER MAKES NO OTHER WARRANTY, GUARANTEE, OR REPRESENTATION OF ANY KIND WHATSOEVER. ALL OTHER WARRANTIES, INCLUDING BUT NOT LIMITED TO, MERCHANTABILITY AND FITNESS FOR PURPOSE, WHETHER EXPRESS, IMPLIED, OR ARISING BY OPERATION OF LAW, TRADE USAGE, OR COURSE OF DEALING ARE HEREBY DISCLAIMED. NOTWITHSTANDING THE FOREGOING, THERE ARE NO WARRANTIES WHATSOEVER ON ITEMS BUILT OR ACQUIRED WHOLLY OR PARTIALLY, TO BUYER'S DESIGNS OR SPECIFICATIONS.**

**5. Limitation Of Remedy: SELLER'S LIABILITY ARISING FROM OR IN ANY WAY CONNECTED WITH THE ITEMS SOLD OR THIS CONTRACT SHALL BE LIMITED EXCLUSIVELY TO REPAIR OR REPLACEMENT OF THE ITEMS SOLD OR REFUND OF THE PURCHASE PRICE PAID BY BUYER, AT SELLER'S SOLE OPTION. IN NO EVENT SHALL SELLER BE LIABLE FOR ANY INCIDENTAL, CONSEQUENTIAL OR SPECIAL DAMAGES OF ANY KIND OR NATURE WHATSOEVER, INCLUDING BUT NOT LIMITED TO LOST PROFITS ARISING FROM OR IN ANY WAY CONNECTED WITH THIS AGREEMENT OR ITEMS SOLD HEREUNDER, WHETHER ALLEGED TO ARISE FROM BREACH OF CONTRACT, EXPRESS OR IMPLIED WARRANTY, OR IN TORT, INCLUDING WITHOUT LIMITATION, NEGLIGENCE, FAILURE TO WARN OR STRICT LIABILITY.**

**6. Changes, Reschedules and Cancellations:** Buyer may request to modify the designs or specifications for the items sold hereunder as well as the quantities and delivery dates thereof, or may request to cancel all or part of this order, however, no such requested modification or cancellation shall become part of the contract between Buyer and Seller unless accepted by Seller in a written amendment to this Agreement. Acceptance of any such requested modification or cancellation shall be at Seller's discretion, and shall be upon such terms and conditions as Seller may require.

**7. Special Tooling:** A tooling charge may be imposed for any special tooling, including without limitation, dies, fixtures, molds and patterns, acquired to manufacture items sold pursuant to this contract. Such special tooling shall be and remain Seller's property notwithstanding payment of any charges by Buyer. In no event will Buyer acquire any interest in apparatus belonging to Seller which is utilized in the manufacture of the items sold hereunder, even if such apparatus has been specially converted or adapted for such manufacture and notwithstanding any charges

paid by Buyer. Unless otherwise agreed, Seller shall have the right to alter, discard or otherwise dispose of any special tooling or other property in its sole discretion at any time.

**8. Buyer's Property:** Any designs, tools, patterns, materials, drawings, confidential information or equipment furnished by Buyer or any other items which become Buyer's property, may be considered obsolete and may be destroyed by Seller after two (2) consecutive years have elapsed without Buyer placing an order for the items which are manufactured using such property. Seller shall not be responsible for any loss or damage to such property while it is in Seller's possession or control.

**9. Taxes:** Unless otherwise indicated on the face hereof, all prices and charges are exclusive of excise, sales, use, property, occupational or like taxes which may be imposed by any taxing authority upon the manufacture, sale or delivery of the items sold hereunder. If any such taxes must be paid by Seller or if Seller is liable for the collection of such tax, the amount thereof shall be in addition to the amounts for the items sold. Buyer agrees to pay all such taxes or to reimburse Seller therefore upon receipt of its invoice. If Buyer claims exemption from any sales, use or other tax imposed by any taxing authority, Buyer shall save Seller harmless from and against any such tax, together with any interest or penalties thereon which may be assessed if the items are held to be taxable.

**10. Indemnity For Infringement of Intellectual Property Rights:** Seller shall have no liability for infringement of any patents, trademarks, copyrights, trade dress, trade secrets or similar rights except as provided in this Part 10. Seller will defend and indemnify Buyer against allegations of infringement of U.S. Patents, U.S. Trademarks, copyrights, trade dress and trade secrets (hereinafter "Intellectual Property Rights"). Seller will defend at its expense and will pay the cost of any settlement or damages awarded in an action brought against Buyer based on an allegation that an item sold pursuant to this contract infringes the Intellectual Property Rights of a third party. Seller's obligation to defend and indemnify Buyer is contingent on Buyer notifying Seller within ten (10) days after Buyer becomes aware of such allegations of infringement, and Seller having sole control over the defense of any allegations or actions including all negotiations for settlement or compromise. If an item sold hereunder is subject to a claim that it infringes the Intellectual Property Rights of a third party, Seller may, at its sole expense and option, procure for Buyer the right to continue using said item, replace or modify said item so as to make it noninfringing, or offer to accept return of said item and return the purchase price less a reasonable allowance for depreciation. Notwithstanding the foregoing, Seller shall have no liability for claims of infringement based on information provided by Buyer, or directed to items delivered hereunder for which the designs are specified in whole or part by Buyer, or infringements resulting from the modification, combination or use in a system of any item sold hereunder. The foregoing provisions of this Part 10 shall constitute Seller's sole and exclusive liability and Buyer's sole and exclusive remedy for infringement of Intellectual Property Rights.

If a claim is based on information provided by Buyer or if the design for an item delivered hereunder is specified in whole or in part by Buyer, Buyer shall defend and indemnify Seller for all costs, expenses or judgments resulting from any claim that such item infringes any patent, trademark, copyright, trade dress, trade secret or any similar right.

**11. Force Majeure:** Seller does not assume the risk of and shall not be liable for delay or failure to perform any of Seller's obligations by reason of circumstances beyond the reasonable control of Seller (hereinafter "Events of Force Majeure"). Events of Force Majeure shall include without limitation, accidents, acts of God, strikes or labor disputes, acts, laws, rules or regulations of any government or government agency, fires, floods, delays or failures in delivery of carriers or suppliers, shortages of materials and any other cause beyond Seller's control.

**12. Entire Agreement/Governing Law:** The terms and conditions set forth herein, together with any amendments, modifications and any different terms or conditions expressly accepted by Seller in writing, shall constitute the entire Agreement concerning the items sold, and there are no oral or other representations or agreements which pertain thereto. This Agreement shall be governed in all respects by the law of the State of Ohio. No actions arising out of the sale of the items sold hereunder or this Agreement may be brought by either party more than two (2) years after the cause of action accrues.

9/01-P



**Parker Hannifin Corporation**

Chelsea Products Division

8225 Hacks Cross Road

Olive Branch, Mississippi 38654 USA

Tel: (662) 895-1011

Fax: (662) 895-1019

[www.parker.com/chelsea](http://www.parker.com/chelsea)